

**N3 INDUSTRY**  
Quality Is Our Priority

**C A T A L A O G U E   D E N T A L   I N S T R U M E N T S**

**2022 - 2023 COLLECTION**

[www.n3Industry.com](http://www.n3Industry.com)



# index

<b>01</b>	Tooth Extracting Forceps		<b>01-49</b>
<b>02</b>	Root Elevators		<b>50-70</b>
<b>03</b>	Scalpel Handles, Handles, Mouth Mirrors Scalers, Explorer / Probes		<b>71-85</b>
<b>04</b>	Endodontic Condensers, Obturation Instruments Excavators, Explorer / Probes, Curette Sets		<b>86-96</b>
<b>05</b>	Amalgam Pluggers / Condensers, Burnishers		<b>97-100</b>
<b>06</b>	Wax Carvers, Carvers, Chisels		<b>101-103</b>
<b>07</b>	Compsite Placement, Plastic Filling Instruments		<b>104-107</b>
<b>08</b>	Curettes, Gracey Curettes, Dental Products, Knives		<b>108-117</b>



## index

<b>09</b>	Wax Porcelain & Cement Instruments Wax & Modeling Instruments		<b>118-121</b>
<b>10</b>	Spatulas, Cement Spatulas		<b>122-124</b>
<b>11</b>	Files, Hoes, Knives, Wax & Plaster Knives, Crane Kaplan		<b>125-128</b>
<b>12</b>	Bone Curettes, Bone Files, Bone Chisels, Bone Mallets		<b>129-133</b>
<b>13</b>	Crown Removers, Crown Instruments		<b>134-136</b>
<b>14</b>	Implants & Measuring Instruments, Suction Tubes, Bone Gauges		<b>137-144</b>
<b>15</b>	Amalgam Guns & Carriers, Retainers, Bands, Strip Holders, Napkin Holders		<b>145-146</b>
<b>16</b>	Rubber Dam Instruments, Rubber Dam Clamps		<b>147-148</b>

## index

<b>17</b>	Syringes, Tweezers, Sterilizing & Lab Instruments		<b>149-156</b>
<b>18</b>	Endodontic Forceps, Tissue Forceps, Haemostatic Forceps, Towel Clamps		<b>157-159</b>
<b>19</b>	Retractors, Lip & Cheek Retractors, Hooks, Depressors & Mouth Gags, Sterilizing Forceps		<b>160-164</b>
<b>20</b>	Orthodontic Pliers & Cutters, Rongeurs		<b>165-179</b>
<b>21</b>	Needle Holders, Scissors, Micro Surgery Set		<b>180-186</b>
<b>22</b>	Impression Trays		<b>187-193</b>
<b>23</b>	Articulators, Hollow Wares		<b>194-200</b>
<b>24</b>	Scissors, Dissecting Forceps, Needle Holders, Wire Cutting Pliers With Tungsten Carbide Inserts		<b>201-213</b>



## Section - 01



- ★ Extracting Forceps
- ★ Root Elevators

## Extracting Forceps "English Pattern"



1001  
Fig. 4  
lower incisor



1001  
Fig. 4  
lower incisor



1002  
Fig. 8  
lower premolar



1002  
Fig. 8  
lower premolars



## Extracting Forceps "English Pattern"



**1003**  
Fig. 1  
upper centrals & canines



**1004**  
Fig. 2  
upper laterals & canines



**1005**  
Fig. 3  
upper incisors & canines



**1006**  
Fig. 4  
upper incisors & canines



**1007**  
Fig. 7  
upper premolars



**1008**  
Fig. 8  
lower premolars



**1009**  
Fig. 13  
lower premolars

## Extracting Forceps "English Pattern"



**1010**  
Fig. 13S  
lower premolars  
for children.

**1011**  
Fig. 17  
upper molars, right

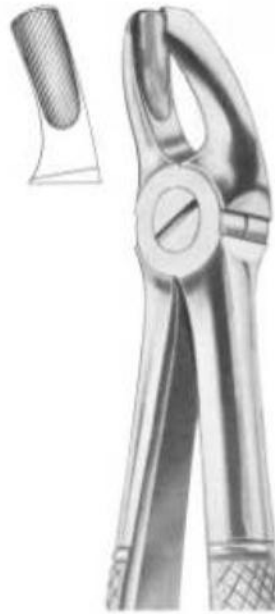

**1012**  
Fig. 18  
upper molars, left



**1013**  
Fig. 18A  
upper molars



**1014**  
Fig. 13S  
upper molars



**1015**  
Fig. 19  
upper third molars

## Extracting Forceps "English Pattern"



**1016**  
Fig. 20  
upper third molars



**1017**  
Fig. 21  
lower molars



**1018**  
Fig. 22  
lower molars



**1019**  
Fig. 22S  
lower molars  
for children



**1020**  
Fig. 22G  
lower molars



**1021**  
Fig. 23  
lower molars, right



**1022**  
Fig. 24  
lower molars, left



## Extracting Forceps "English Pattern"



1023  
Fig. 29  
upper roots



1024  
Fig. 29S  
upper roots for children



1025  
Fig. 30  
upper roots

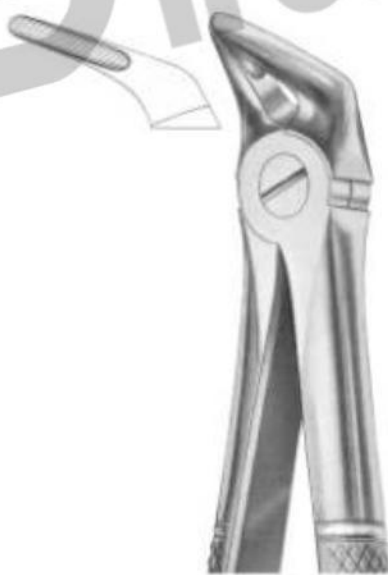

1026  
Fig. 31  
lower roots



1027  
Fig. 32  
lower molars



1028  
Fig. 30S  
upper roots  
for children



## Extracting Forceps "English Pattern"



**1030**  
Fig. 33A  
lower roots

**1031**  
Fig. 33B  
lower roots

**1029**  
Fig. 33  
lower roots

**1032**  
Fig. 33L  
lower roots

**1033**  
Fig. 37  
upper incisors  
for children

**1034**  
Fig. 33S  
lower roots  
for children

## Extracting Forceps "English Pattern"



**1035**  
Fig. 38  
lower incisors &  
canines for children



**1036**  
Fig. 39  
upper molars  
for children



**1037**  
Fig. 39R  
upper molars right  
for children



**1040**  
Fig. 39L  
upper molars left  
for children



**1038**  
Fig. 39A  
upper molars  
for children



**1039**  
Fig. 40  
lower molars  
for children

## Extracting Forceps "English Pattern"



1041  
Fig. 41  
upper roots

1042  
Fig. 44  
upper roots

1043  
Fig. 45  
lower roots

1044  
Fig. 48  
lower roots

1045  
Fig. 49  
upper roots

1046  
Fig. 50  
upper roots

## Extracting Forceps "English Pattern"



1048  
Fig. 51A  
upper roots

1049  
Fig. 51L  
upper roots

1047  
Fig. 51  
upper roots

1050  
Fig. 52  
upper roots

1051  
Fig. 52A  
upper teeth  
and resection

1052  
Fig. 51S  
upper roots  
for children



## Extracting Forceps "English Pattern"



**1053**  
Fig. 54  
for separating  
upper molars

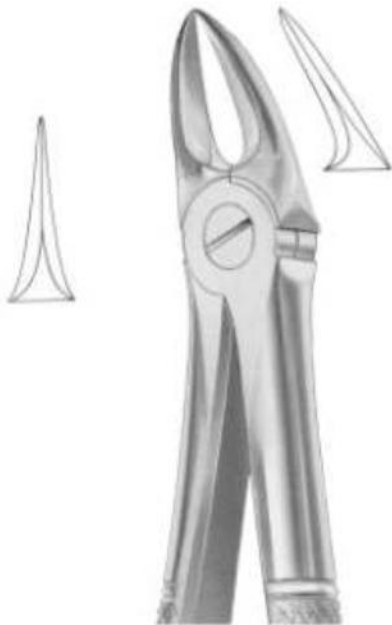

**1054**  
Fig. 55  
for separating  
upper molars



**1055**  
Fig. 56  
for separating  
lower molars

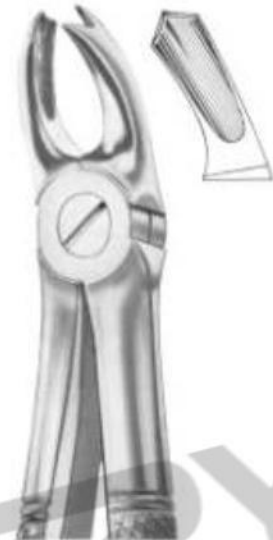

**1056**  
Fig. 65R  
upper molars  
right



**1057**  
Fig. 65L  
upper molars left



**1058**  
Fig. 67  
upper third molars



**1059**  
Fig. 67A  
upper third molars

## Extracting Forceps "English Pattern"



**1060**  
Fig. 67 1/2 R  
upper third molars  
right

**1061**  
Fig. 67 1/2 L  
upper third molars  
left



**1062**  
Fig. 68  
lower roots

**1063**  
Fig. 68A  
lower roots



**1064**  
Fig. 73  
lower molars

**1065**  
Fig. 73R  
lower molars right

**1066**  
Fig. 73L  
lower molars left

## Extracting Forceps "English Pattern"



1067  
Fig. 73A  
lower molars



1068  
Fig. 73S  
lower molars



1069  
Fig. 73B  
lower molars for children



1072  
Fig. 73K  
lower molars  
for children



1070  
Fig. 74  
lower roots



1071  
Fig. 74D  
lower roots

## Extracting Forceps "English Pattern"



**1073**  
Fig. 74M  
lower roots



**1074**  
Fig. 74N  
lower roots



**1075**  
Fig. 74XN  
lower roots and  
crowded incisors



**1078**  
Fig. 76N  
upper roots



**1076**  
Fig. 75  
lower premolars



**1077**  
Fig. 76  
upper roots



## Extracting Forceps "English Pattern"



**1079**  
Fig. 76S  
upper roots



**1080**  
Fig. 79  
lower third molars



**1081**  
Fig. 79A  
lower third molars



**1082**  
Fig. 81  
lower premolars  
and roots

## Extracting Forceps "English Pattern"



**1083**  
Fig. 86A  
lower molars



**1084**  
Fig. 86B  
lower molars



**1085**  
Fig. 86C  
lower molars



**1086**  
Fig. 87  
lower molars



**1087**  
Fig. 91  
for separating  
lower molars



**1088**  
Fig. 99  
lower molars

## Extracting Forceps "English Pattern"



**1089**  
Fig. 101  
upper premolars  
and roots



**1090**  
Fig. 100  
upper roots



**1091**  
Fig. 99 1/4  
lower molars



**1092**  
Fig. 99 1/2  
lower molars



## Extracting Forceps "English Pattern"



**1093**  
Fig. 102  
upper molars right



**1094**  
Fig. 103  
upper molars left



**1095**  
Fig. 105  
lower incisors



**1096**  
Fig. 106  
lower incisors



**1097**  
Fig. 103  
upper canines

## Extracting Forceps "English Pattern"



1098  
Fig. 112  
upper roots

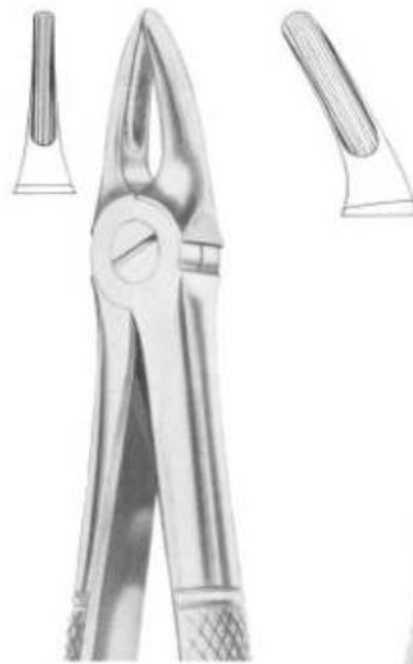

1099  
Fig. 113  
upper roots



1101  
Fig. 136  
upper premolars  
and roots



1102  
Fig. 137  
lower incisors  
and roots



1100  
Fig. 114  
upper roots



1103  
Fig. 143  
lower roots

## Extracting Forceps "English Pattern"

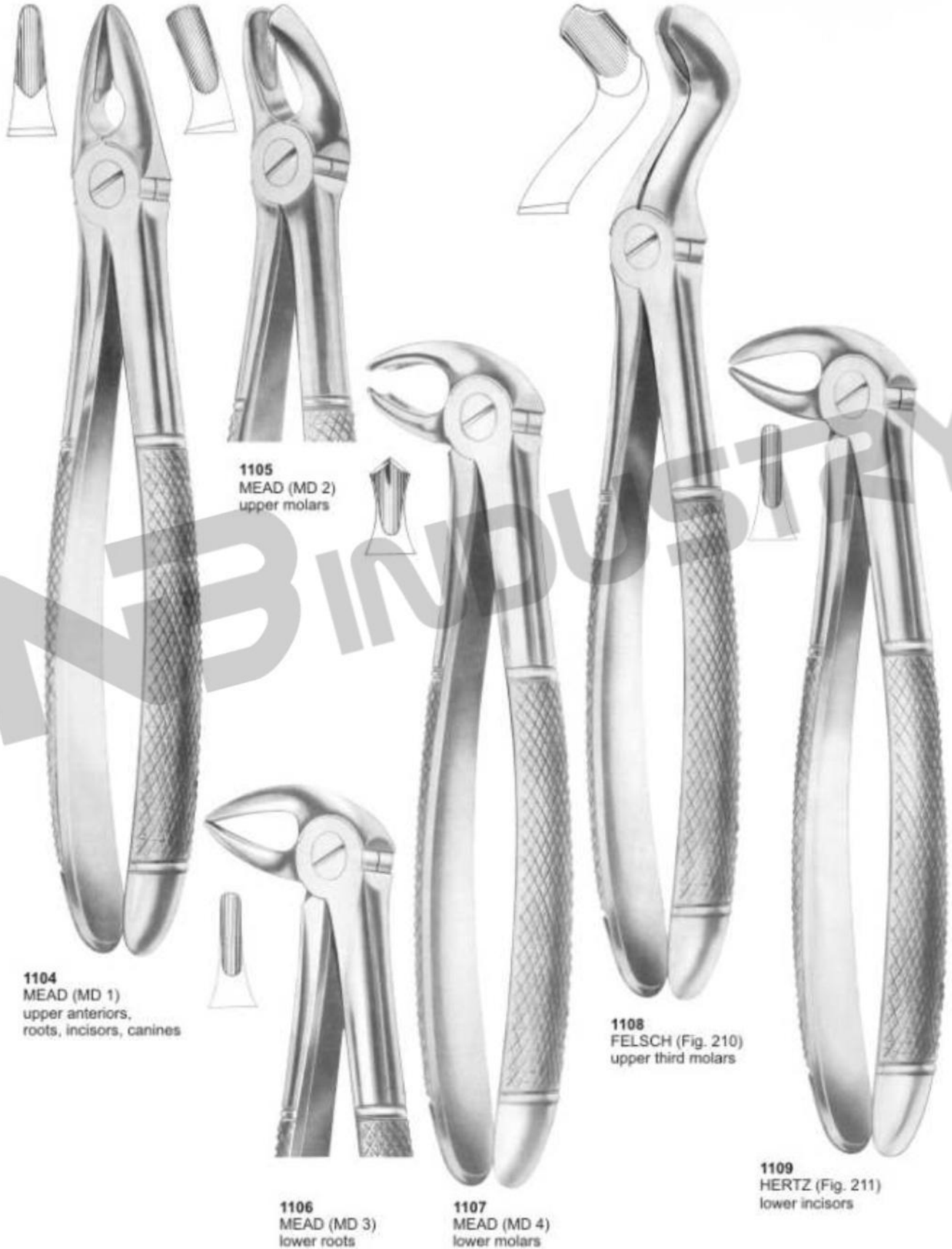

**1104**  
MEAD (MD 1)  
upper anteriors,  
roots, incisors, canines

**1105**  
MEAD (MD 2)  
upper molars

**1106**  
MEAD (MD 3)  
lower roots

**1107**  
MEAD (MD 4)  
lower molars

**1108**  
FELSCH (Fig. 210)  
upper third molars

**1109**  
HERTZ (Fig. 211)  
lower incisors



## Extracting Forceps "English Pattern"



**1110**  
ROUTURIER (Fig. 212)  
( 22 ½ L )  
lower molars  
and wisdom left



**1111**  
ROUTURIER (Fig. 213)  
( 22 ½ R )  
lower molars  
and wisdom right



**1112**  
ROUTURIER (Fig. 214)  
( 22 ½ L )  
lower molars  
and wisdom left



**1113**  
ROUTURIER (Fig. 215)  
( 33 ½ R )  
lower molars  
and wisdom right



**1114**  
RESECTION FORCEPS  
( 216/Witzel )  
upper roots

## Extracting Forceps "English Pattern"



1115  
Fig. 5



1116  
Fig. 6



1117  
Fig. 9



1118  
Fig. 10



1119  
Fig. 11



1120  
Fig. 12



1121  
Fig. 14



1122  
Fig. 15

## Extracting Forceps "English Pattern"



1123  
Fig. 25



1124  
Fig. 26



1125  
Fig. 27



1126  
Fig. 28



1127  
Fig. 34



1128  
Fig. 35



1129  
Fig. 42



1130  
Fig. 43



## Extracting Forceps "English Pattern"



1131  
Fig. 44A



1132  
Fig. 46



1133  
Fig. 47



1134  
Fig. 50A



1135  
Fig. 74R



1136  
Fig. 74L



1137  
Fig. 75R



1138  
Fig. 75L

## Extracting Forceps "English Pattern"

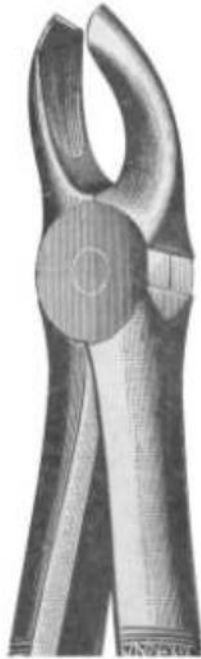

1139  
Fig. 94



1140  
Fig. 95



1141  
Fig. 98



1142  
Fig. 105



1143  
Fig. 106



1144  
Fig. 2002

## Extracting Forceps "With Fitting Handle"

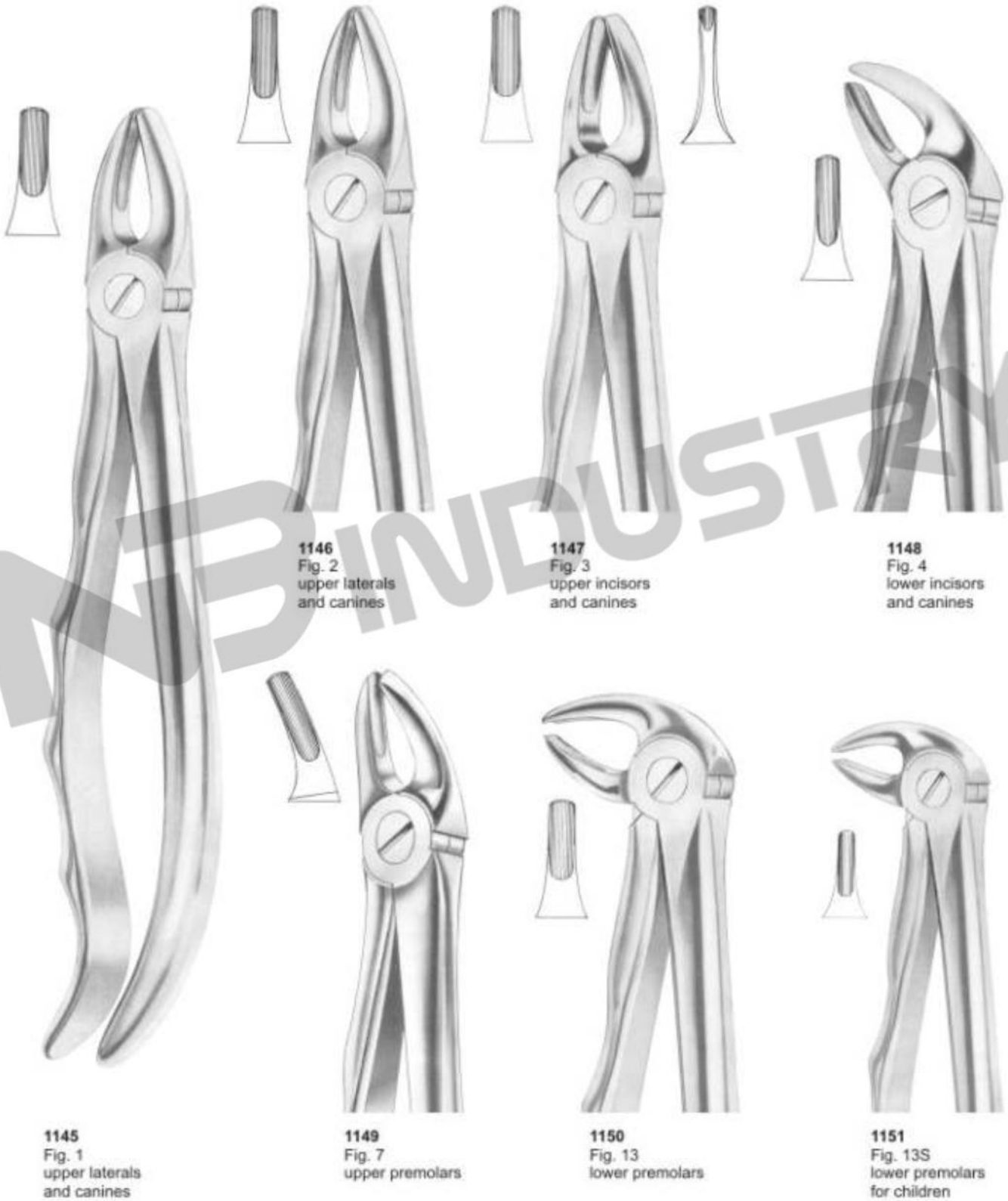

**1146**  
Fig. 2  
upper laterals  
and canines

**1147**  
Fig. 3  
upper incisors  
and canines

**1148**  
Fig. 4  
lower incisors  
and canines

**1145**  
Fig. 1  
upper laterals  
and canines

**1149**  
Fig. 7  
upper premolars

**1150**  
Fig. 13  
lower premolars

**1151**  
Fig. 13S  
lower premolars  
for children



## Extracting Forceps "With Fitting Handle"



1152  
Fig. 17  
upper molars right



1153  
Fig. 18  
upper molars left



1154  
Fig. 18A  
upper molars



1155  
Fig. 18B  
upper molars



1156  
Fig. 19  
upper third molars



1157  
Fig. 22  
lower molars



1158  
Fig. 22S  
lower molars  
for children

## Extracting Forceps "With Fitting Handle"



1159  
Fig. 29  
upper roots



1160  
Fig. 29S  
upper roots  
for children



1161  
Fig. 30  
upper roots



1162  
Fig. 30S  
upper roots  
for children



1163  
Fig. 33  
lower roots



1164  
Fig. 33A  
lower roots



1165  
Fig. 33B  
lower roots

## Extracting Forceps "With Fitting Handle"



**1166**  
Fig. 33L  
lower roots



**1167**  
Fig. 33S  
lower roots  
for children



**1168**  
Fig. 37  
upper incisors  
for children



**1169**  
Fig. 39  
upper incisors  
for children



**1170**  
Fig. 39A  
upper molars  
for children



**1171**  
Fig. 39R  
upper molars right  
for children



**1172**  
Fig. 39L  
upper molars left  
for children



## Extracting Forceps "With Fitting Handle"



1173  
Fig. 41  
upper roots

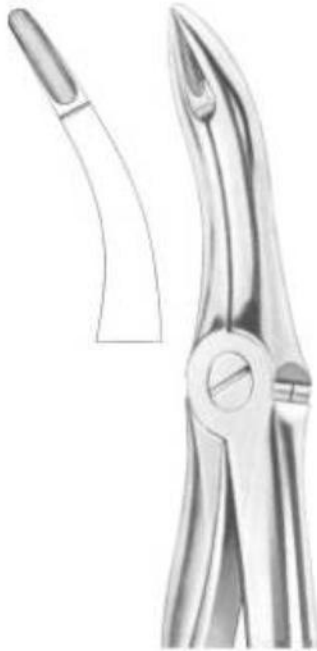

1174  
Fig. 44  
upper roots

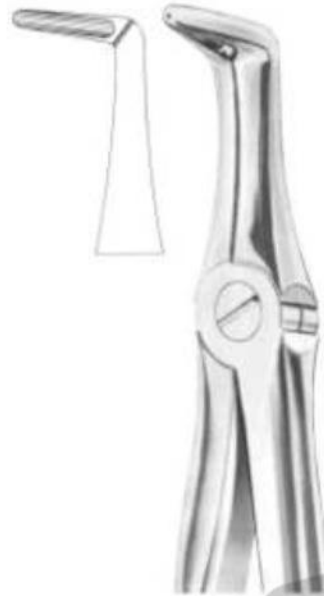

1175  
Fig. 45  
lower roots



1176  
Fig. 48  
lower roots



1177  
Fig. 51  
upper roots



1178  
Fig. 51A  
upper roots



1179  
Fig. 51S  
upper roots  
for children

## Extracting Forceps "With Fitting Handle"



**1180**  
Fig. 51L  
upper roots

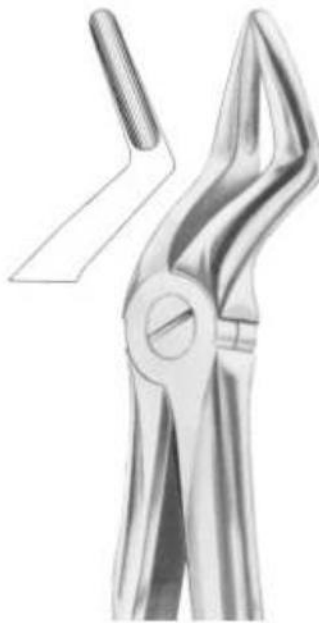

**1181**  
Fig. 52  
upper roots



**1182**  
Fig. 54  
for separating  
upper molars



**1183**  
Fig. 65R  
upper molars right



**1184**  
Fig. 65L  
upper molars left



**1185**  
Fig. 67  
upper third molars

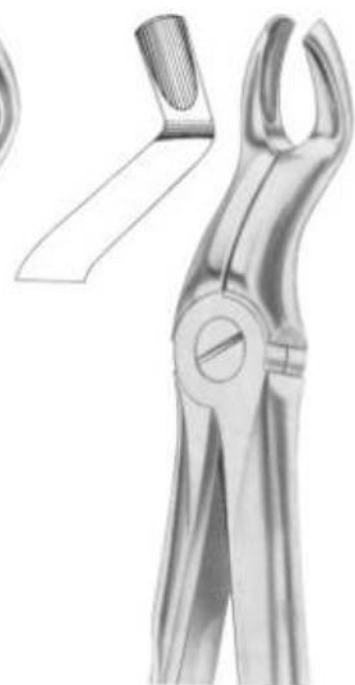

**1186**  
Fig. 67A  
upper third molars

## Extracting Forceps "With Fitting Handle"



**1187**  
Fig. 67 1/2 R  
upper third molars  
right



**1188**  
Fig. 67 1/2 L  
upper third molars  
left



**1189**  
Fig. 73  
lower molars



**1190**  
Fig. 74  
lower roots



**1191**  
Fig. 74M  
lower roots



**1192**  
Fig. 74N  
lower roots



**1193**  
Fig. 74XN  
lower roots and  
crowded incisors



## Extracting Forceps "With Fitting Handle"



1194  
Fig. 75  
lower premolars



1195  
Fig. 76  
upper roots



1196  
Fig. 76N  
upper roots



1199  
Fig. 79  
lower third molars



1197  
Fig. 81  
lower premolars  
and roots



1198  
Fig. 76A  
lower third molars

## Extracting Forceps "With Fitting Handle"



1200  
Fig. 86A  
lower molars



1201  
Fig. 86B  
lower molars



1202  
Fig. 86C  
lower molars



1203  
Fig. 99  
lower molars



1204  
Fig. 99 1/4  
lower molars



1205  
Fig. 136  
upper premolars  
and roots



1206  
Fig. 143  
lower roots

## Extracting Forceps "For Children"

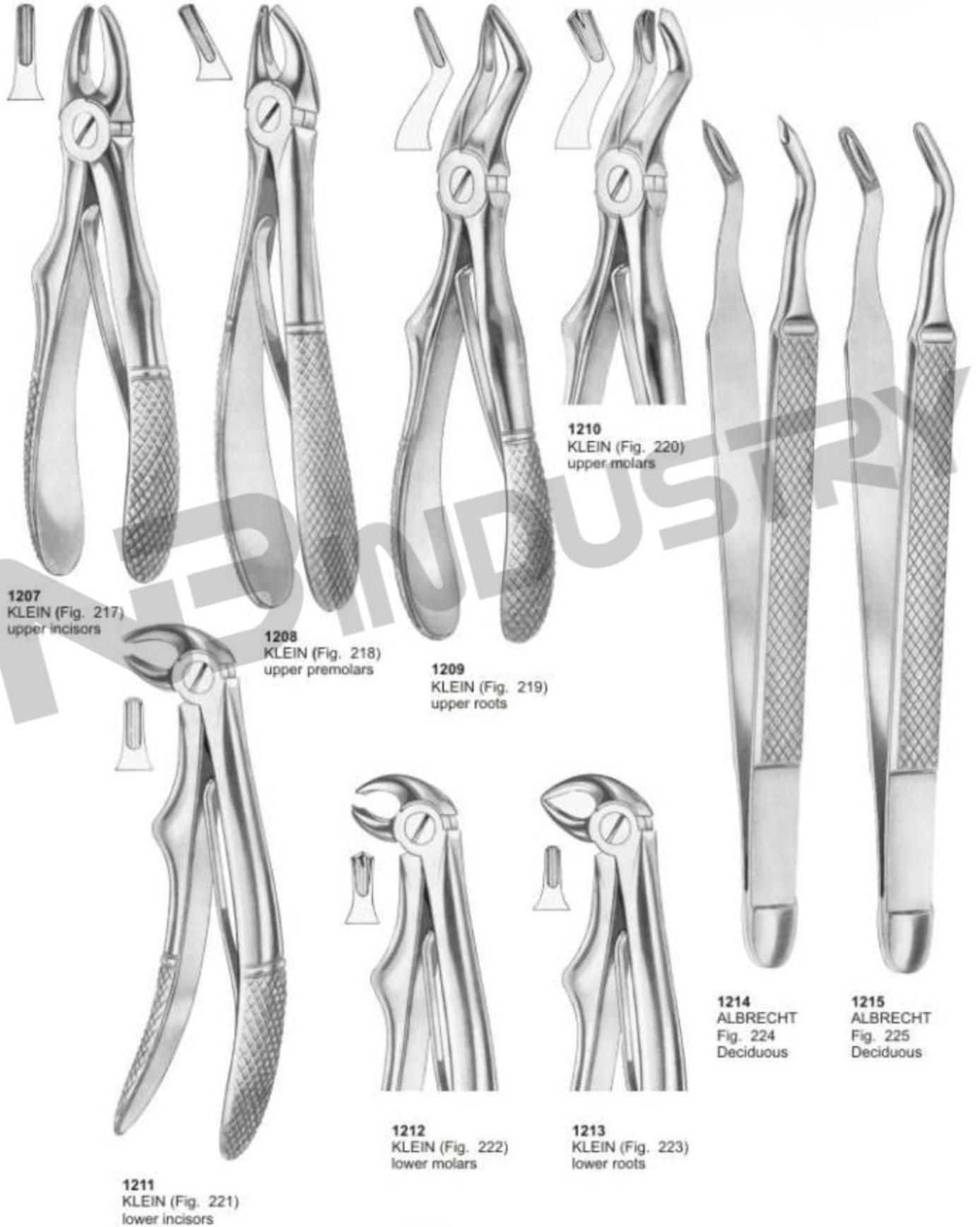



## Root Splinter Forceps

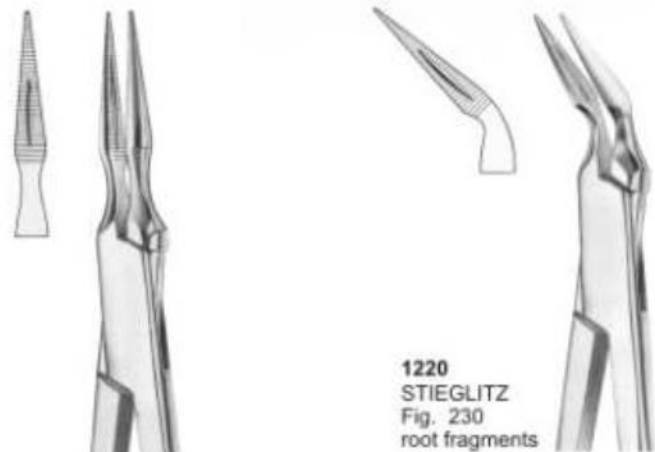
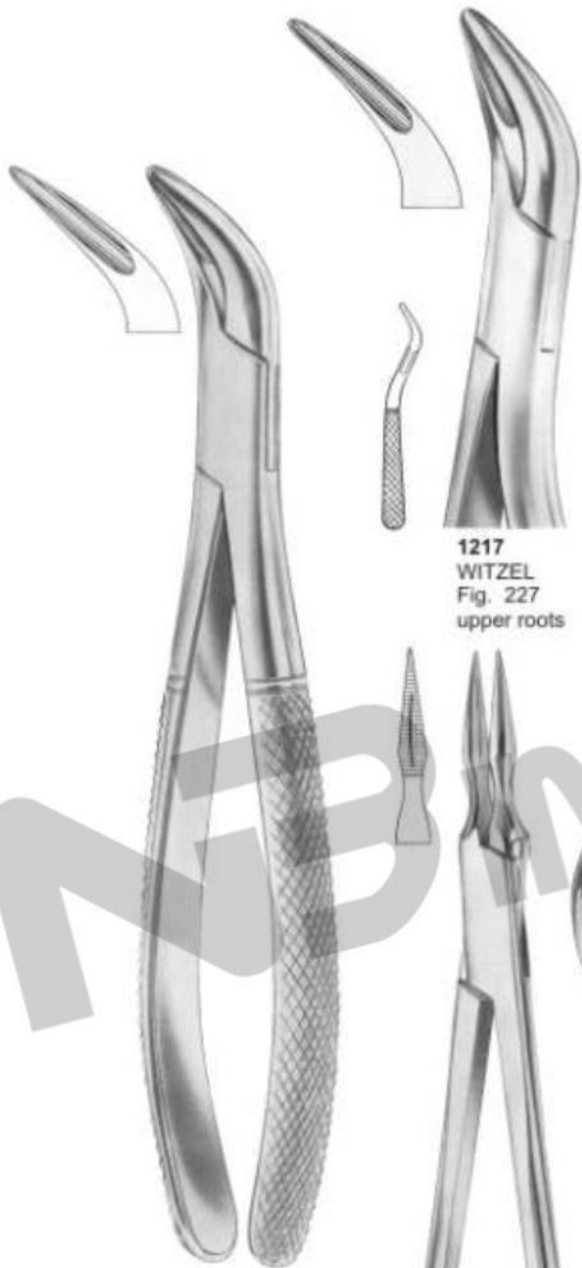

## Extracting Forceps "American Pattern"



**1223**  
Fig. 1  
upper incisors and roots

**1224**  
Fig. 2  
upper and lower roots

**1222**  
W1-WINTER  
upper centrals  
and canines

**1225**  
Fig. 4  
upper and lower premolars

**1226**  
PHYSICK  
Fig. 5  
lower third molars

**1227**  
Fig. 6  
separating  
forceps

## Extracting Forceps "American Pattern"

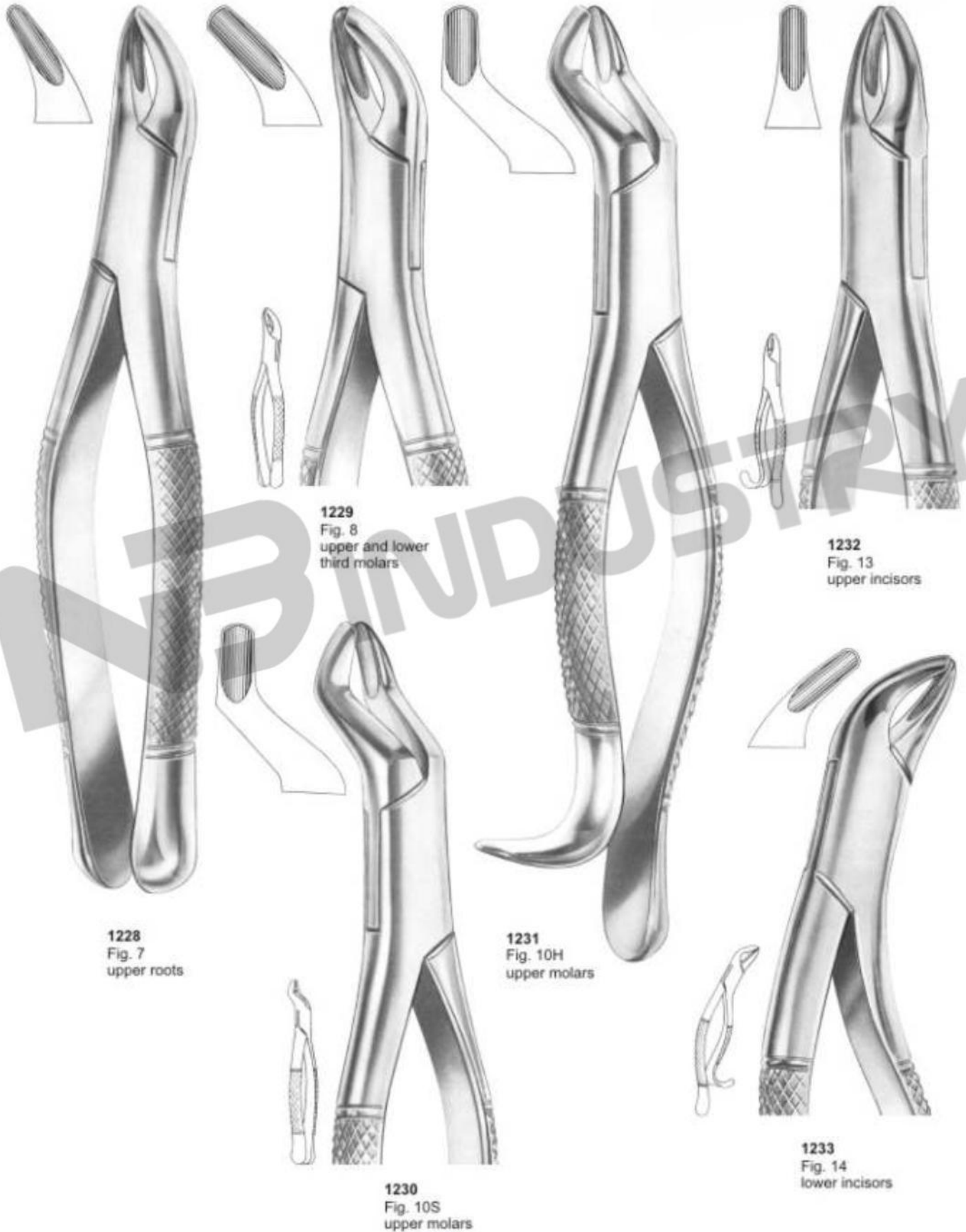



## Extracting Forceps "American Pattern"



1234  
Fig. 16  
lower molars



1235  
HARRIS  
Fig. 15  
lower molars



1237  
HARRIS  
Fig. 18R  
upper molars right



1238  
HARRIS  
Fig. 18L  
upper molars left



1236  
Fig. 16S  
lower molars  
for children

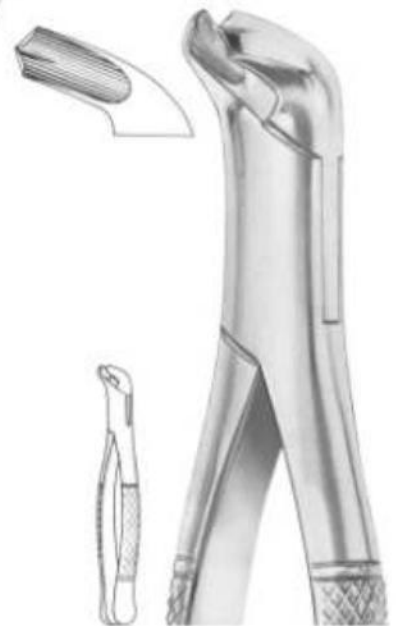

1239  
Fig. 17  
lower molars

## Extracting Forceps "American Pattern"

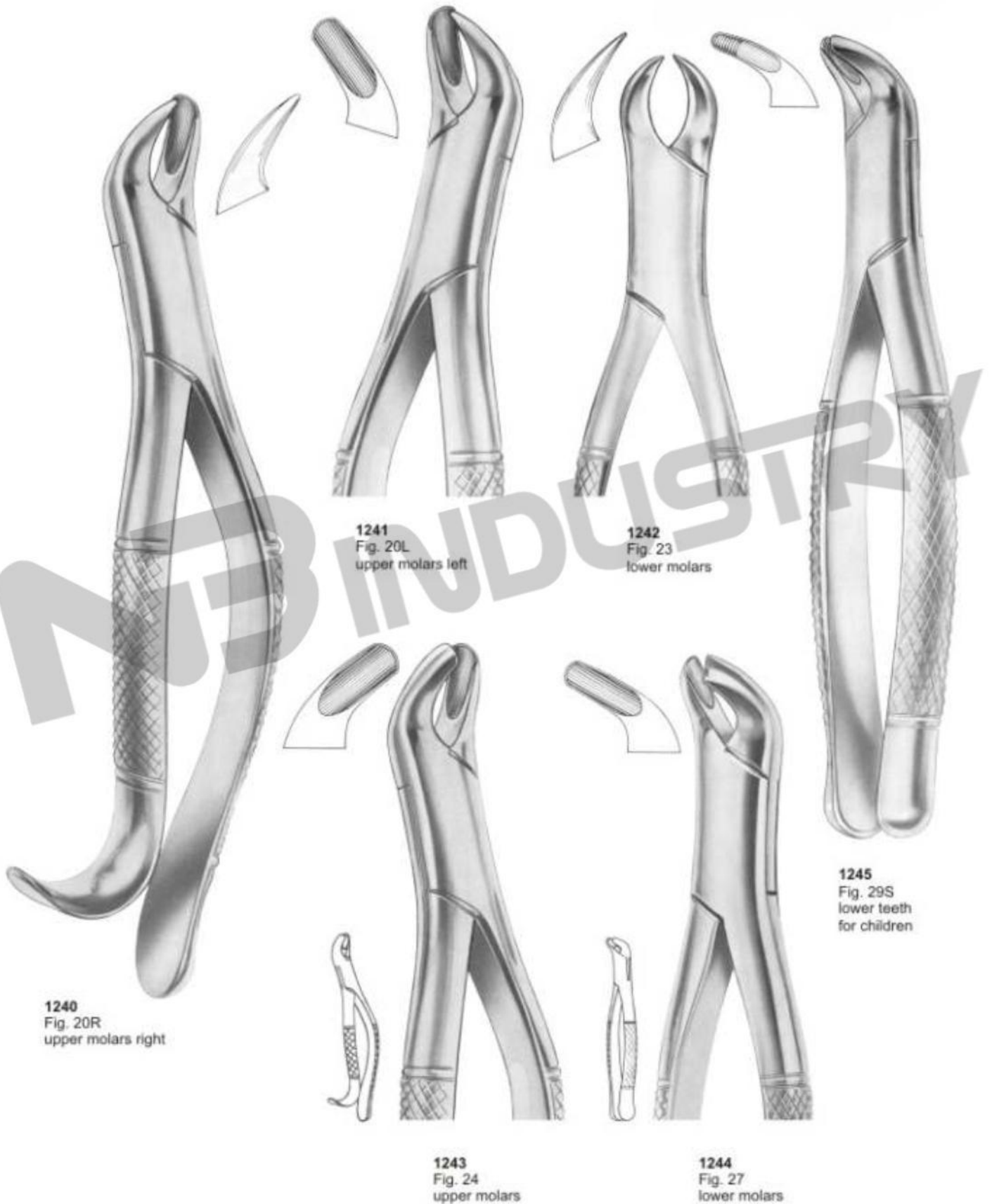

## Extracting Forceps "American Pattern"

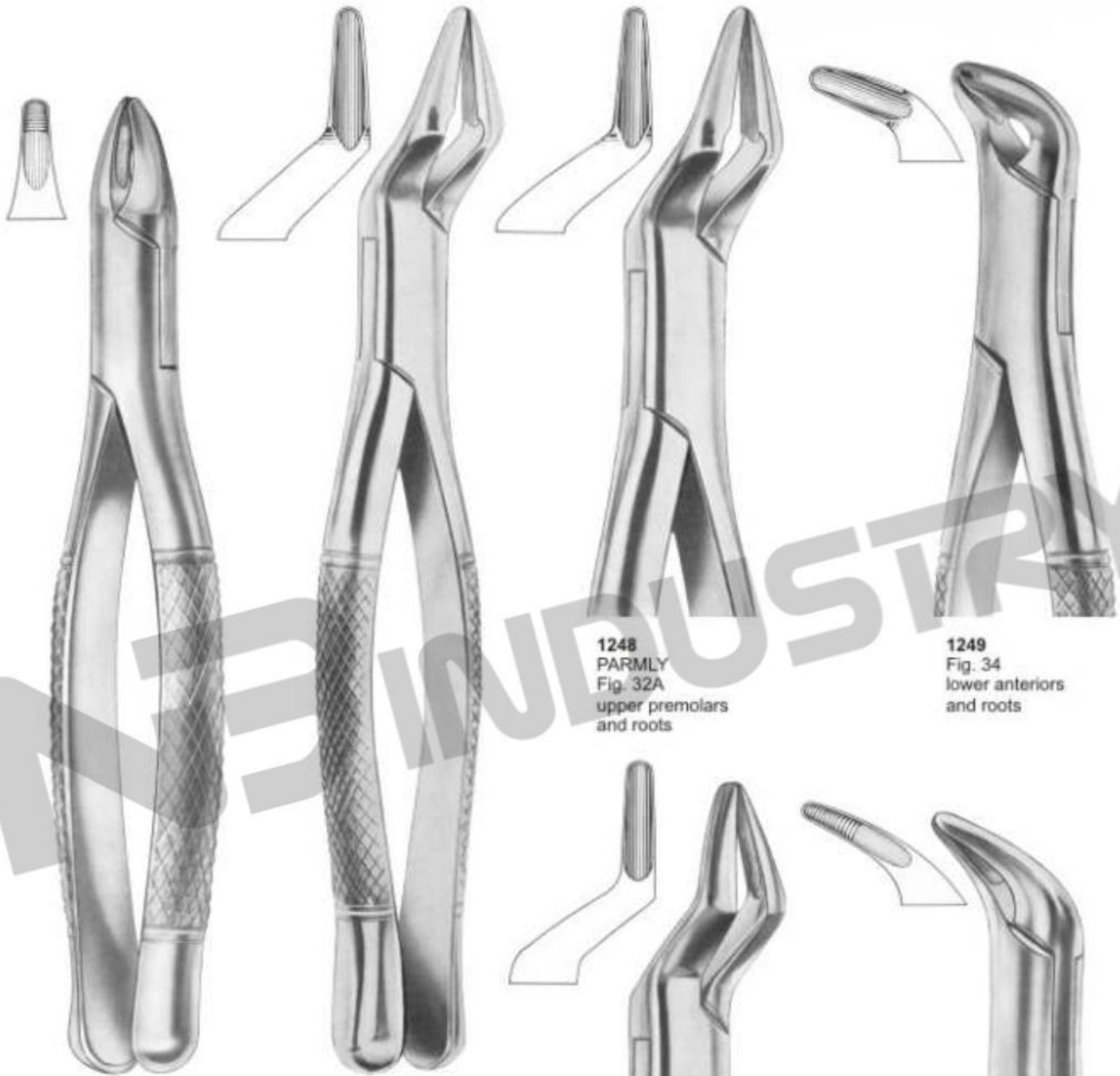

**1246**  
Fig. 30S  
upper teeth  
for children

**1247**  
PARMLY  
Fig. 32  
upper premolars  
and molars

**1248**  
PARMLY  
Fig. 32A  
upper premolars  
and roots

**1249**  
Fig. 34  
lower anteriors  
and roots

**1250**  
Fig. 35  
upper roots

**1251**  
Fig. 36  
lower anteriors  
and roots



## Extracting Forceps "American Pattern"



1252  
Fig. 37  
lower anteriors  
and roots



1254  
Fig. 53R  
upper molars right



1255  
Fig. 53L  
upper molars left



1257  
Fig. 65  
upper incisors  
and roots



1253  
Fig. 38  
upper anteriors  
and roots



1256  
Fig. 62  
incisors, premolars,  
deciduous teeth

## Extracting Forceps "American Pattern"



**1258**  
TOMES  
Fig. 69  
upper and lower roots



**1259**  
TOMES  
Fig. 85  
lower canines,  
premolars and molars

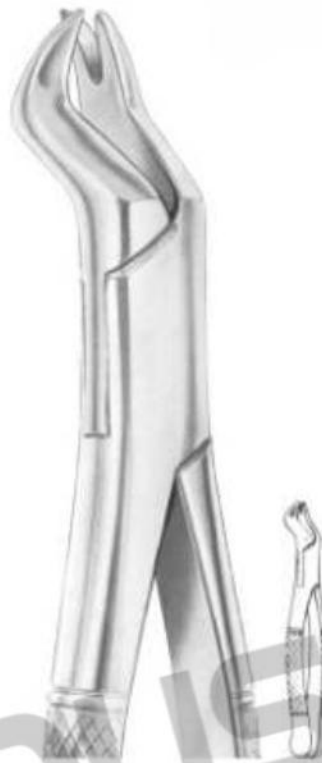

**1260**  
NEVIUS  
Fig. 88R  
upper molars right



**1261**  
THOMAS  
Fig. 85A  
lower canines,



**1262**  
NEVIUS  
Fig. 88L  
upper molars left

## Extracting Forceps "American Pattern"

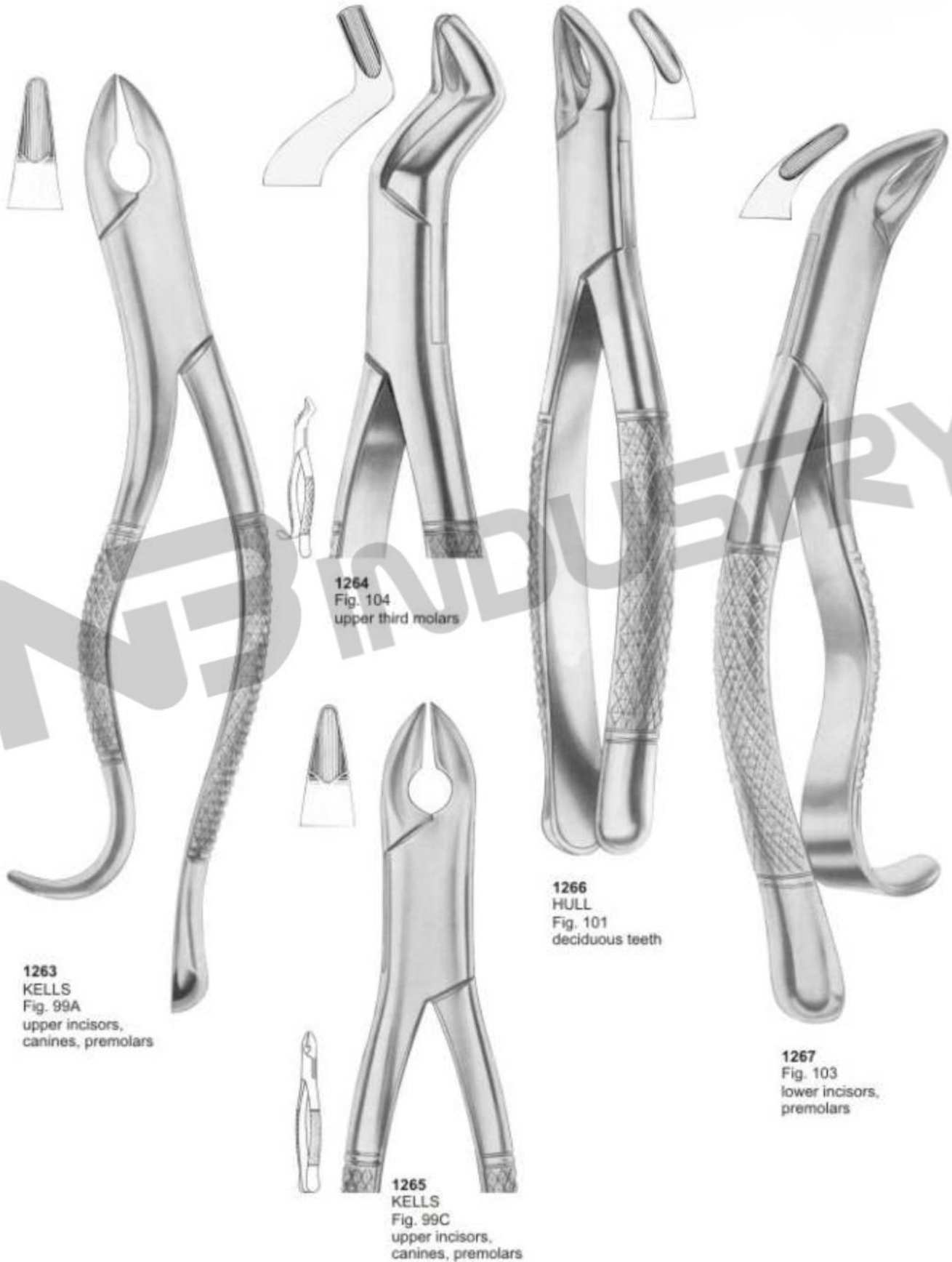



## Extracting Forceps "American Pattern"



**1268**  
CRYER  
Fig. 150  
lower incisors,  
premolars, roots



**1269**  
CRYER  
Fig. 150A  
upper incisors,  
premolars, roots



**1271**  
CRYER  
Fig. 151  
lower incisors,  
premolars, roots



**1272**  
CRYER  
Fig. 151A  
lower incisors,  
premolars, roots



**1270**  
CRYER  
Fig. 150S  
upper teeth for children



**1273**  
CRYER  
Fig. 151S  
lower teeth  
for children

## Extracting Forceps "American Pattern"

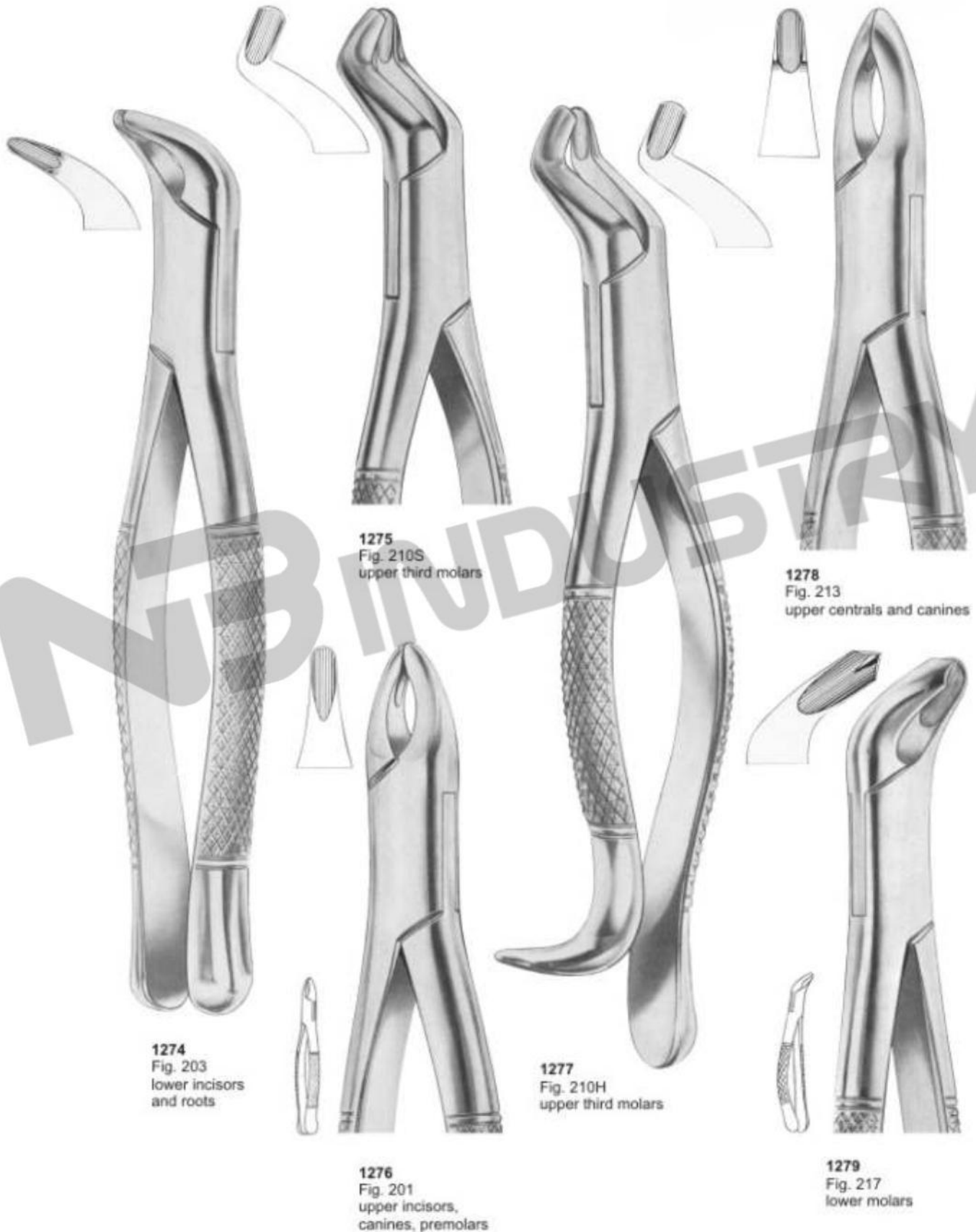

## Extracting Forceps "American Pattern"



1280  
Fig. 222  
lower third molars



1282  
Fig. 286  
Swing lower molars



1283  
Fig. 288  
lower canines  
and premolars



1281  
Fig. 286  
upper incisors and roots



## Extracting Forceps "American Pattern"

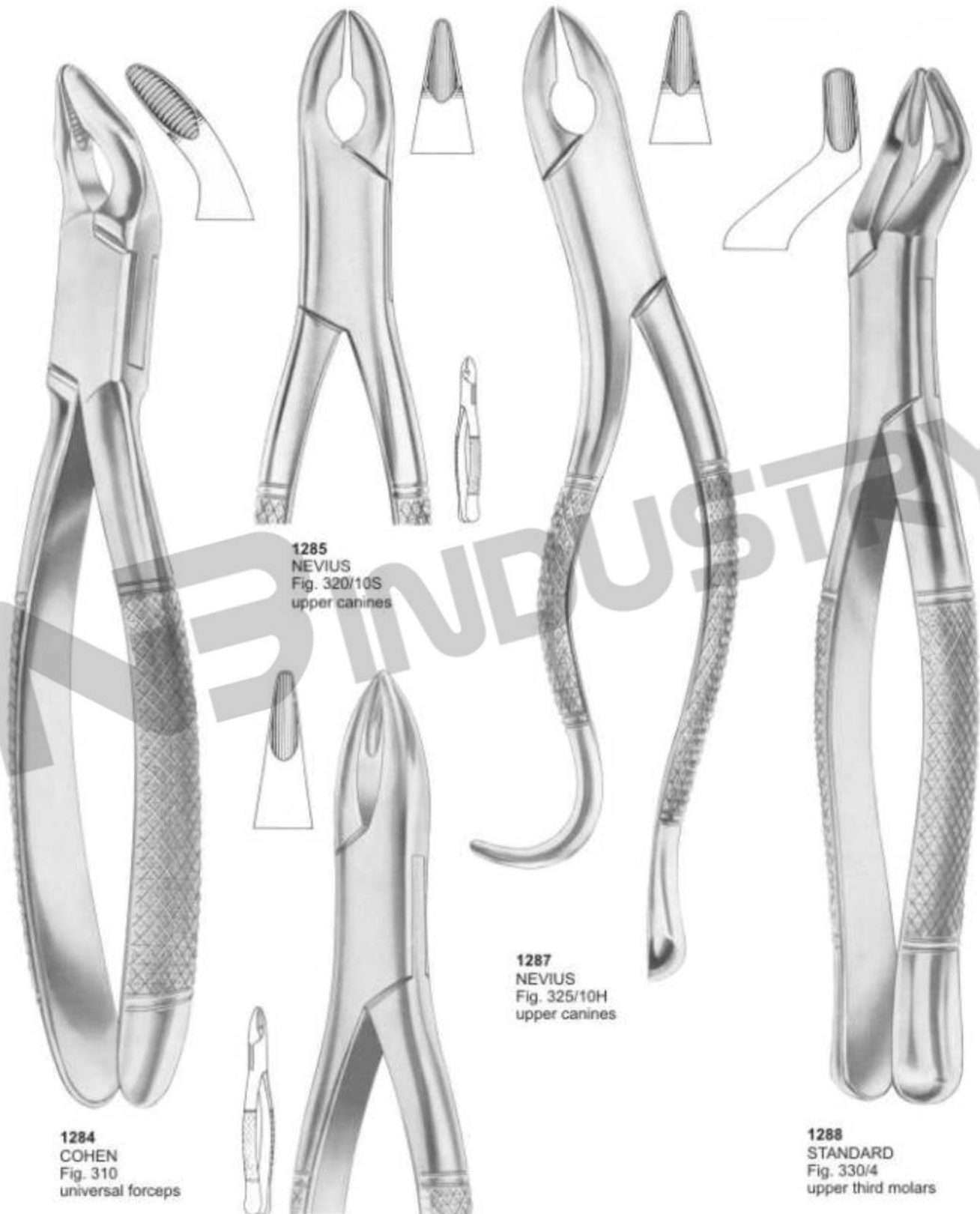

## Extracting Forceps "American Pattern"



## Forceps For Children "American Pattern"



1293  
Fig. 350/23S  
lower molars



1294  
Fig. 355/23SK  
lower molars



1295  
Forcep Fig. 301



1295-A  
Forcep Fig. 300



1296  
Fig. 360/17SK  
lower molars



1297  
Fig. 365/150SK  
upper anteriors  
and roots



1298  
Fig. 370/151SK  
lower anteriors  
and roots



## Peristeel Elevators



1299  
Molt 9

1300  
Allen 9A

1301  
Prichard

1302  
Seldin

1303  
Goldman- Fox 14

1304  
West  
Dell W2

## Elevators

### Heidbrink Root - Tip Picks

#### Root Tip





1314  
BUSER

1315  
OHI 10

1316  
HOWARD 9H

1317  
FREER

1318  
FREER 15

1319  
FREER 16



## Root Elevators

lower jaw, left side

lower jaw, right side



1320  
BEIN  
Fig. 4



1331

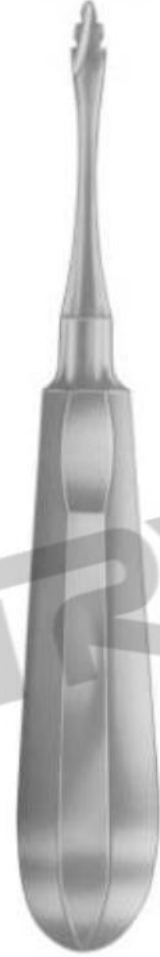

1332

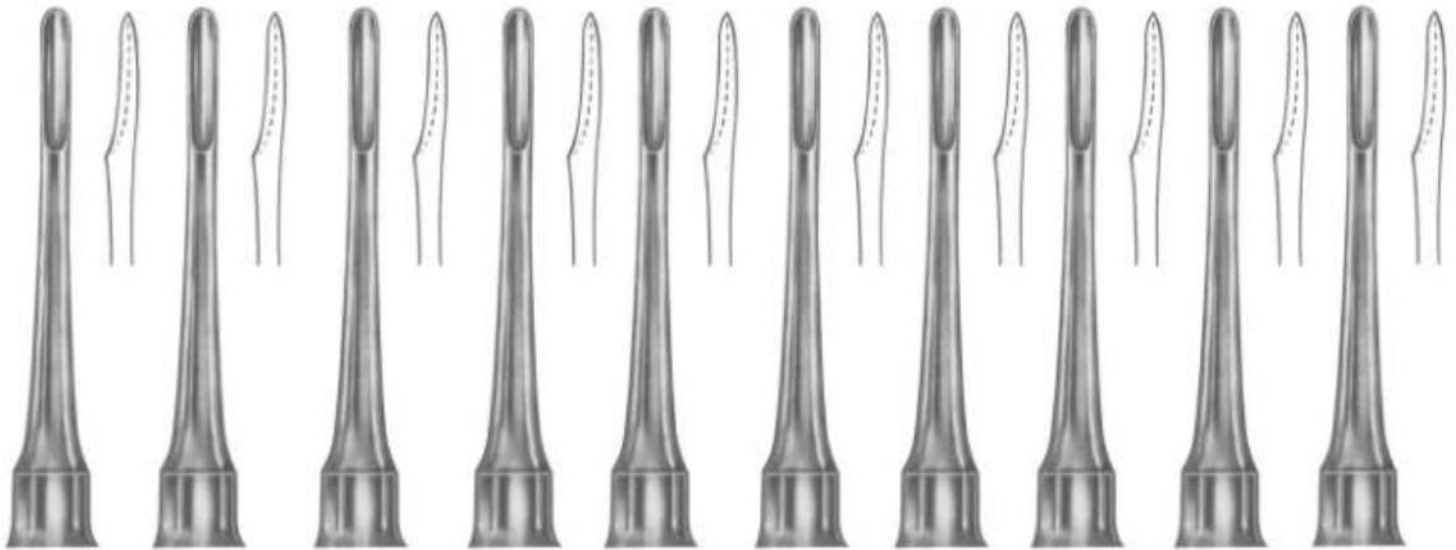

1321  
BEIN  
1.0 mm

1322  
BEIN  
1.5 mm

1323  
BEIN  
2.0 mm

1324  
BEIN  
2.5 mm

1325  
BEIN  
3.0 mm

1326  
BEIN  
3.5 mm

1327  
BEIN  
4.0 mm

1328  
BEIN  
4.5 mm

1329  
BEIN  
5.0 mm

1330  
BEIN  
5.5 mm

## Root Elevators



1333  
BEIN



1334  
BEIN  
Fig. 1



1335  
BEIN  
Fig. 2



1336  
BEIN  
Fig. 0



1337  
BEIN  
Fig. 3



1338  
BEIN  
Fig. 4



1339  
BEIN  
Fig. 5



1340  
BEIN  
Fig. 6

## Root Elevators



1341  
CRYER  
Fig. 3



1342  
CRYER  
Fig. 4



1343  
CRYER  
Fig. 12



1344  
CRYER  
Fig. 27



1345  
CRYER  
Fig. 28



1346  
CRYER  
Fig. 27S



1347  
CRYER  
Fig. 28S



1348  
SELDIN  
Fig. 2



1349  
SELDIN  
Fig. 3



1350  
SELDIN  
Fig. 4L



1351  
SELDIN  
Fig. 4R



1352  
SELDIN  
Fig. 1L



1353  
SELDIN  
Fig. 1R



## Swa Elevators & Root Screws



1354



1355



1356



1357



1358



1359



1360

### Root Screws



1362  
Morrison  
2.0 mm



1363  
Morrison  
2.5 mm



1364  
Morrison  
3.0 mm



1361  
Morrison  
3.5 mm

## Root Elevators



**1366**  
APICAL  
2 mm  
Fig. 1

**1367**  
APICAL  
3 mm  
Fig. 2

**1368**  
APICAL  
4 mm  
Fig. 3

**1369**  
APICAL  
4.5 mm  
Fig. 4

**1370**  
APICAL  
2 mm  
Fig. 5

**1371**  
APICAL  
3 mm  
Fig. 6

**1372**  
APICAL  
4 mm  
Fig. 7

**1373**  
APICAL  
4.5 mm  
Fig. 8

**1374**  
APICAL  
Fig. 9

**1365**  
IS-APICAL

**1375**  
WINTER  
Fig. 14 L

**1376**  
WINTER  
Fig. 14 R

**1377**  
HEIDBRINK  
Fig. 1

**1378**  
HEIDBRINK  
Fig. 2

**1379**  
FLOHR  
Fig. 1

**1380**  
FLOHR  
Fig. 2

**1381**  
APICAL  
Fig. 1

**1382**  
APICAL  
Fig. 2

## Root Elevators



1383  
IS-CRYER



1384  
CRYER  
Fig. 1



1385  
CRYER  
Fig. 2



1386  
IS-COUPLAND



1387  
COUPLAND  
Fig. 1



1388  
COUPLAND  
Fig. 2



1389  
COUPLAND  
Fig. 3





1390  
Fig. 1



1391  
Fig. 2



1392  
Fig. 3



1393  
FLOHR  
Fig. 1



1394  
FLOHR  
Fig. 2



1395  
FLOHR  
Fig. 3

## Root Elevators



1396  
KOPP  
Fig. 1



1397  
KOPP  
Fig. 2



1403  
KOPP  
Fig. 1



1404  
KOPP  
Fig. 2



1396  
KOPP



1398  
KOPP  
Fig. 3



1399  
KOPP  
Fig. 4



1405  
KOPP  
Fig. 3



1406  
KOPP  
Fig. 4



1402  
KOPP



1400  
KOPP  
Fig. 5



1401  
KOPP  
Fig. 6

## Root Elevators

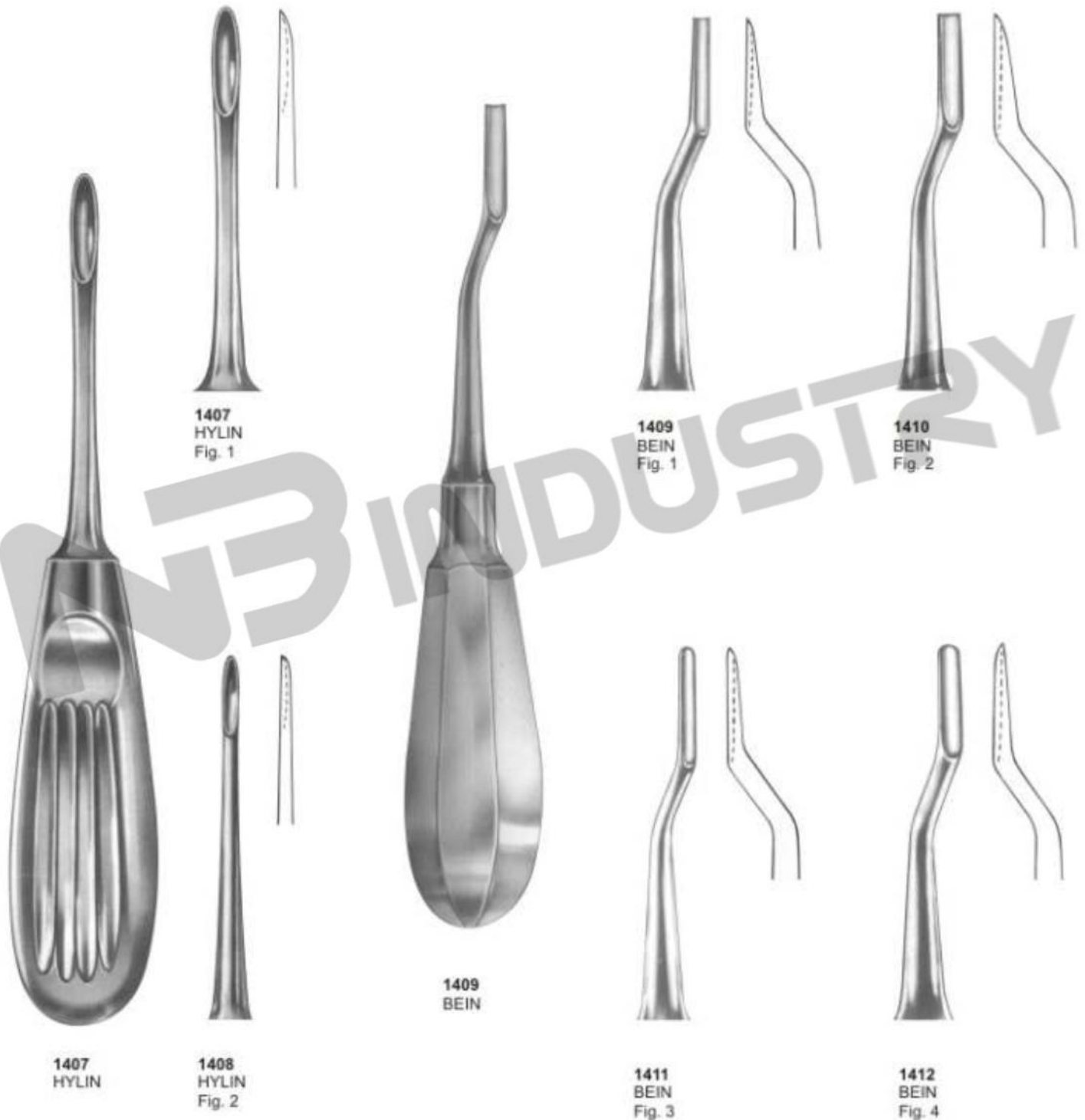

1407  
HYLIN  
Fig. 1

1409  
BEIN  
Fig. 1

1410  
BEIN  
Fig. 2

1409  
BEIN

1407  
HYLIN

1408  
HYLIN  
Fig. 2

1411  
BEIN  
Fig. 3

1412  
BEIN  
Fig. 4



1413  
WARWICK-JAMES  
Fig. 1



1413  
Warwick-James  
Fig. 2

1414  
Warwick-James  
Fig. 3



1415  
London-Hospital  
Fig. 1



1415  
London-Hospital  
Fig. 2

1416  
London-Hospital  
Fig. 3



1417  
OTT



## Root Elevators



1418  
CHOMPRET  
Fig. 1



1419  
CHOMPRET  
Fig. 2



1420  
CHOMPRET  
Fig. 3



1421  
CHOMPRET  
Fig. 4



1423  
Fig. 1



1422  
Fig. 2



1424  
Fig. 1



1425  
Fig. 2



1426  
APICAL

## Root Tip Elevators



1427  
IS-Fig. 1



1428  
Fig. 2



1429  
Fig. 3



1430  
HEIDBRINK  
Fig. 1



1431  
HEIDBRINK  
Fig. 2



1432  
HEIDBRINK  
Fig. 3



1438  
MEAD  
MD1



1433  
LECLUSE



1434  
MEAD



1435  
MEAD



1436  
MEAD



1437  
MEAD

## Root Elevators



1439  
WINTER  
Fig. 1L



1440  
WINTER  
Fig. 1R



1441  
WINTER  
Fig. 2L



1442  
WINTER  
Fig. 2R



1443  
WINTER  
Fig. 11L



1444  
WINTER  
Fig. 11R



1445  
WINTER  
Fig. 12L



1446  
WINTER  
Fig. 12R



1439  
WINTER



1447  
WINTER  
Fig. 14L



1448  
WINTER  
Fig. 14R

## Root Elevators



1449  
BARRY  
Fig. 1



1450  
BARRY  
Fig. 2



1451  
BARRY  
Fig. 3



1452  
BARRY  
Fig. 4



1449  
BARRY



1453  
BARRY  
Fig. 11



1454  
BARRY  
Fig. 12



1455  
BARRY  
Fig. 17



1456  
BARRY  
Fig. 18





1458  
CRYER  
Fig. 26



1459  
SELDIN  
Fig. 27



1460  
CRYER  
Fig. 28



1461  
CRYER  
Fig. 29



1462  
HEIDBRINK  
Fig. 22



1463  
HEIDBRINK  
Fig. 23



1457

## Root Elevators



1465  
KOPP  
Fig. 31



1466  
KOPP  
Fig. 32



1467  
KOPP  
Fig. 33



1468  
KOPP  
Fig. 34



1469  
KOPP  
Fig. 35



1470  
KOPP  
Fig. 44



1464

## Root Elevators



1472  
HEIDBRINK  
Fig. 10



1473  
WINTER  
Fig. 11



1474  
WINTER  
Fig. 12



1475  
BARRY  
Fig. 17



1476  
BARRY  
Fig. 18



1477  
BARRY  
Fig. 20



1471

Root Elevators according to Dr. Sader,  
with interchangeable working tips



1478



1479



1480

## Elevators Plastic Handle

1481  
Root Elevator, Plastic Handle, Set of 10 Pcs

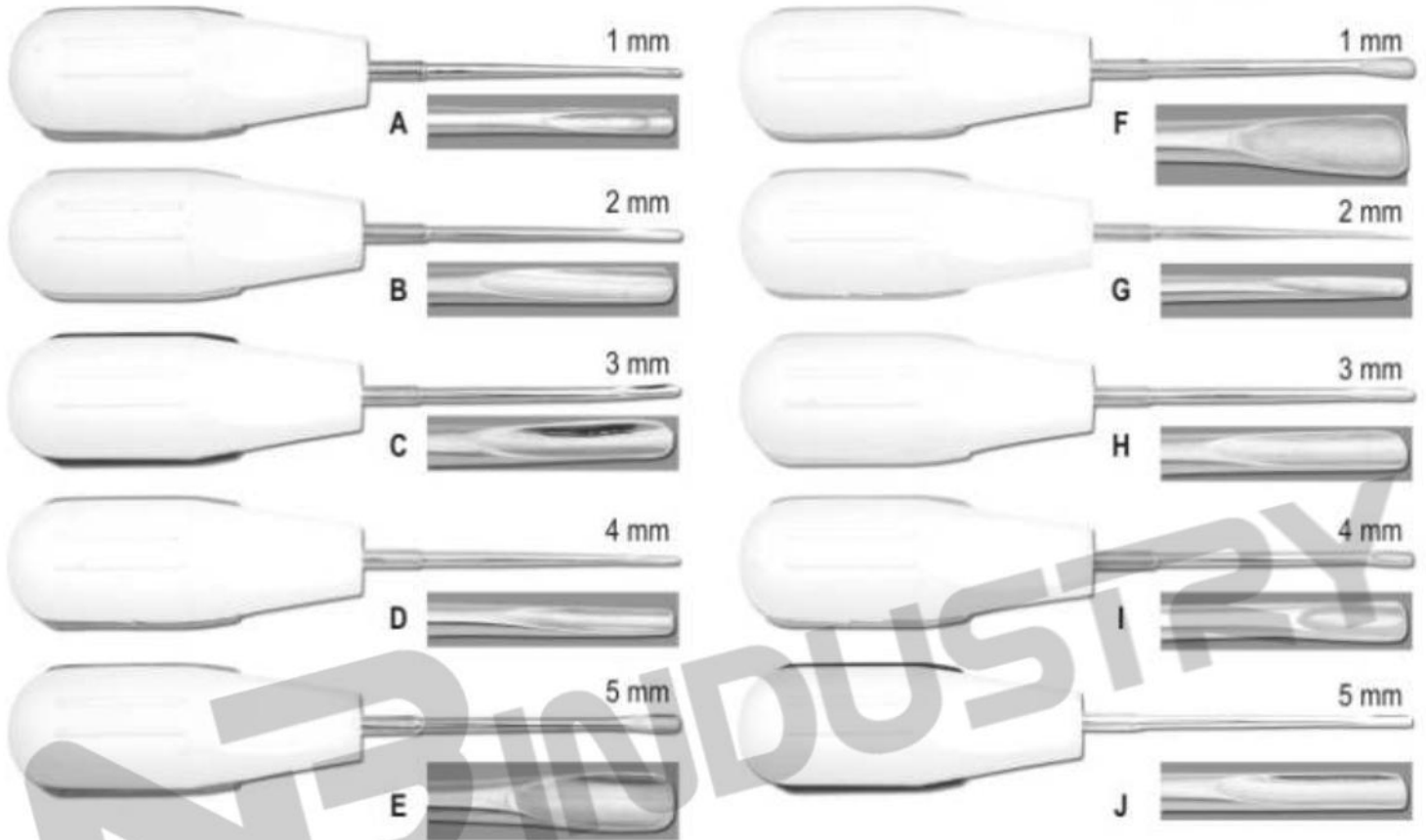

1482  
Root Elevator, Plastic Handle, Set of 5 Pcs

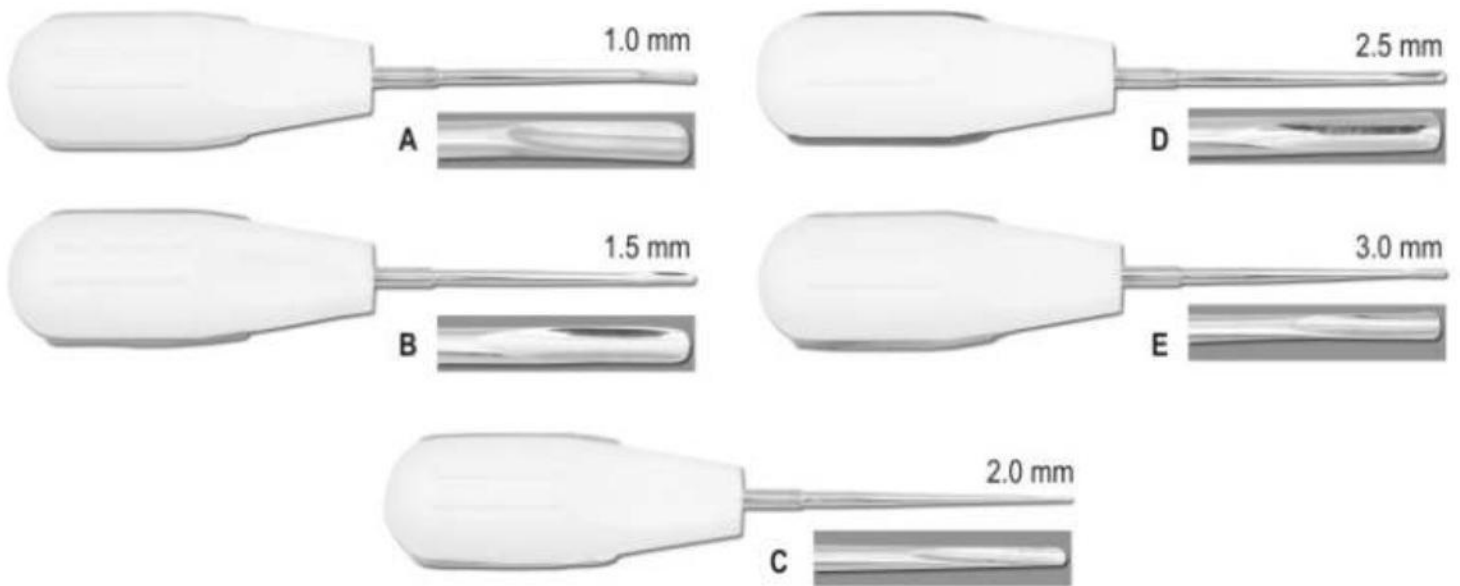



## Section - 02



- \* Scalpel Handles
- \* Mouth Mirrors, Handles
- \* Scalers
- \* Explorers
- \* Probes
- \* Condensers
- \* Excavators



## Scalpel Handles



1483

Scalpel Handle Angle Of Blade Adjusts To Easily Get Around Corners  
Adjustment Sets Blade From Straight To Back Angled  
Locks In At 90°, 60°, 30°, Straight, -30°, -60° Angles



1484  
Scalpel Handle  
Fig. 5



1485  
Scalpel Handle  
Curved



1486  
Fig. 3L



1487  
Fig. 7



1488  
Scalpel Handle  
Fig. 4L, Curved  
20 cm



1489  
Fig. 3



1490  
Fig. 3G



1491  
Fig. 4



1492



1493  
Scalpel Handle  
4 D 14.0 cm



1494  
Mess Holders



1495  
Gouge  
Blade Handle  
Fig. 2 / 11.5 cm



## Handles

Handle For Mouth Mirrors, Probes, Explorers, Excavators, Carvers, Curettes & Scalers



1496

Handle No. 2 Standard Single Ended



1497

Handle Single Ended



1498

Handle Single Ended



1499

Handle Single Ended



1500

Octagonal Double Ended



1501

Octagonal Double Ended



1502

Octagonal Double Ended



1503

Handle No. 2 (Standard Double Ended)



1504

Octagonal Double Ended



1505

Tactile Tone Double Ended



1506

Tactile Tone Double Ended

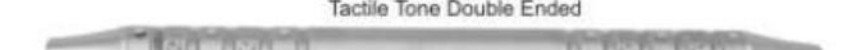

1507

Tactile Tone Double Ended

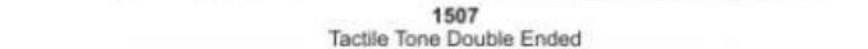

1508

Handle, Double Ended

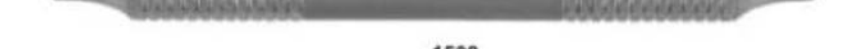

1509

Double Ended



1510

Tactile Tone Double Ended

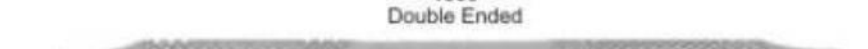

1511

Tactile Tone Double Ended

## Handles & Mouth Mirrors



**1512**  
Hollow Handle  
Fig.1

**1513**  
Hollow Handle  
Fig.2



1513-A

**Mouth Mirrors,  
Magnifying 1513-A  
Plain 1512-B**

Fig. 00	Ø 8 mm
Fig. 0	Ø 10 mm
Fig. 1	Ø 14 mm
Fig. 2	Ø 16 mm
Fig. 3	Ø 18 mm
Fig. 4	Ø 20 mm
Fig. 5	Ø 22 mm
Fig. 6	Ø 24 mm
Fig. 7	Ø 26 mm
Fig. 8	Ø 28 mm
Fig. 9	Ø 30 mm
Fig. 10	Ø 32 mm

**Mouth Mirrors**

Plane



**1514**  
Fig.6  
Ø26 mm

**1515**  
Fig.5  
Ø24 mm

**1516**  
Fig.4  
Ø22 mm

Magnifying



**1517**  
Fig.6  
Ø26 mm

**1518**  
Fig.5  
Ø24 mm

**1519**  
Fig.4  
Ø22 mm

Front surface



**1520**  
Fig.6  
Rhodium  
Ø26 mm  
Front surface

**1521**  
Fig.5  
Rhodium  
Ø24 mm  
Front surface

**1522**  
Fig.4  
Rhodium  
Ø22 mm  
Front surface

Plane



**1523**  
Fig.6  
Ø 26 mm

**1524**  
Fig.5  
Ø24 mm

**1525**  
Fig.4  
Ø22 mm

Magnifying



**1526**  
Fig.6  
Ø 26 mm

**1527**  
Fig.5  
Ø 24 mm

**1528**  
Fig.4  
Ø 22 mm



## Mirror Handle, Mouth Mirrors



1529



1530



1531



1532



1533



1534



1535  
Parallelometer  
mouth mirror

1536  
Parallelometer  
mouth mirror  
+ handle  
code 2101



1537  
Tactile Tone  
Single Ended



1538  
Handle  
Thompson  
Single Ended



1539  
Hollow Handle



1540  
Hollow Handle  
Stainless  
Steel



1541  
Cone-socket  
Hollow Handle



1542  
Hollow Handle



1543  
Hollow Handle

## Scalers

### SCALERS - JAQUETTE

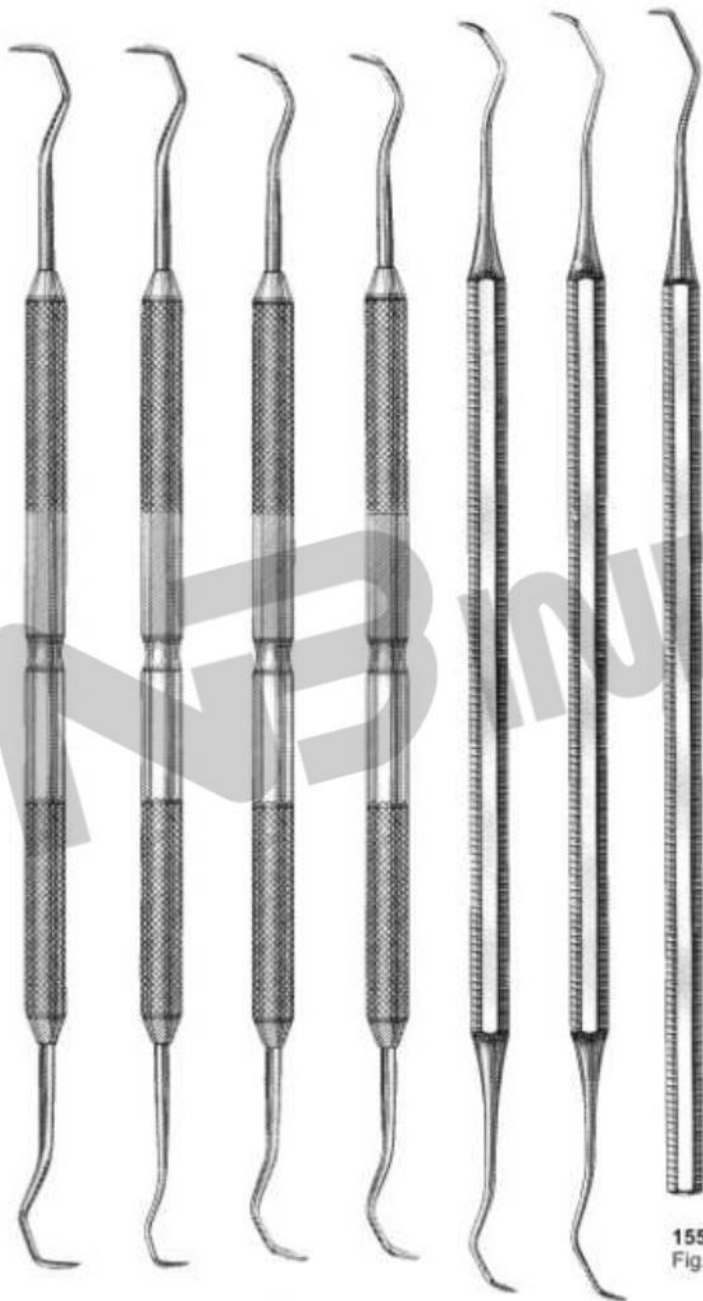

1544 1Y-1Y  
1545 1Y-1YS  
1546 2Y-3Y  
1547 2YS-3YS  
1548 2-3  
1549 2S-3S

1550 Fig-1

### SCALERS - OCTAGONAL

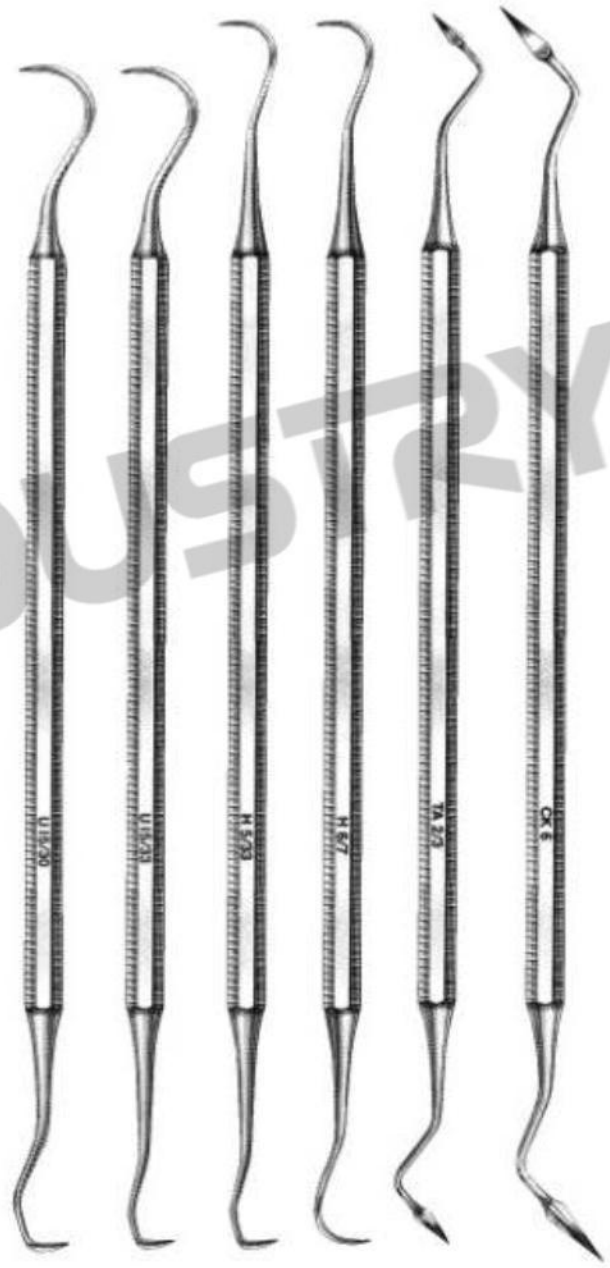

1551 U15-30  
1552 U15-33  
1553 H5-33  
1554 H6-7  
1555 Taylor 2-3  
1556 CK6

## Scalers



1557  
U15



1558  
No. 3



1559  
No. 12



1560  
WHITESIDE 1-0



1561  
WHITESIDE 2-0

## Scalers

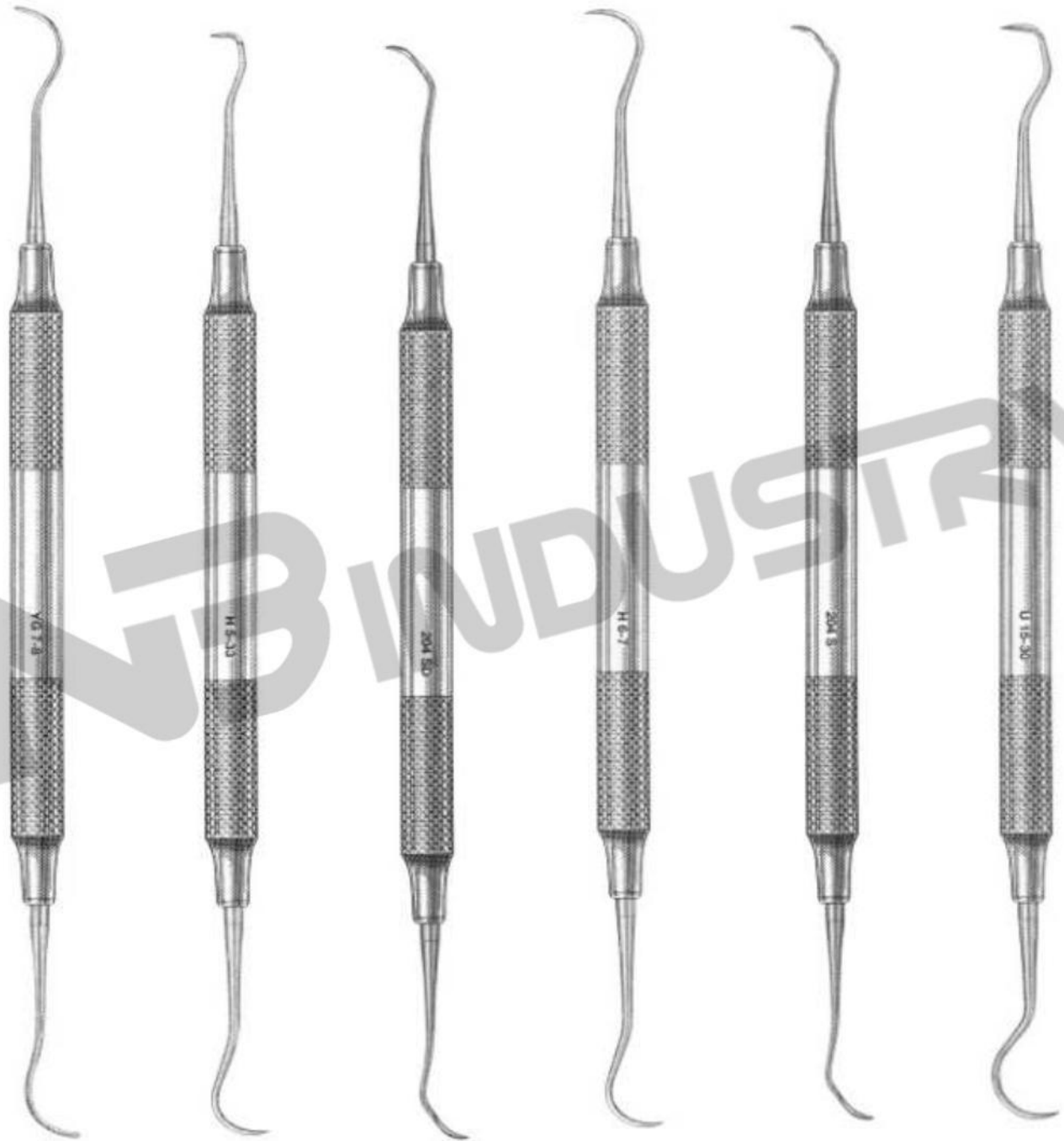

1562  
YAOUNGER/GOOD  
7-8

1563  
H5-33

1564  
204SD

1565  
H6-7

1566  
204S

1567  
TOWNER/JAQUETTE  
U15-30



## Scalers



1568  
JAQUETTE (33-U15)



1569  
JAQUETTE  
2Y-3Y



1570  
JAQUETTE  
30-U15



1571  
JAQUETTE  
2YS-3YS



1572  
JAQUETTE  
33-H5



1573  
YOUNGER/GOOD  
7-8



1574  
204S



1575  
204SD



1576  
H6-7



1577  
JAQUETTE  
2S-3S



1578  
JAQUETTE  
1Y-1YS



1579  
JAQUETTE  
2-3

## Scalers



1580  
JAQUETTE (33-U15)



1581  
S204



1583  
S204S

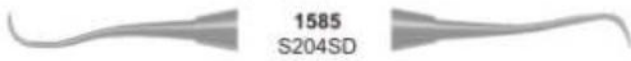

1585  
S204SD



1587  
Goldman 6-7



1589  
Goldman Fox 21



1591  
H5-U15

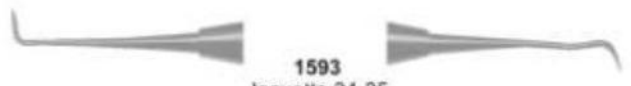

1593  
Jaquette 34-35

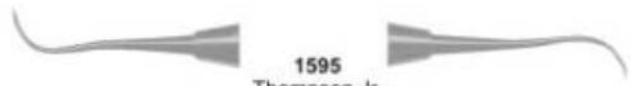

1595  
Thompson Jr.

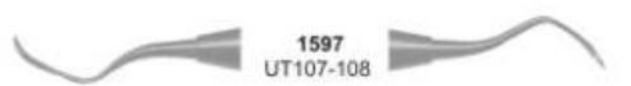

1597  
UT107-108



1599  
UP128



1582  
Jack-Nebraska

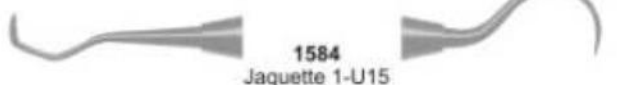

1584  
Jaquette 1-U15



1586  
Jaquette 2-3



1588  
Jaquette 2S-3S

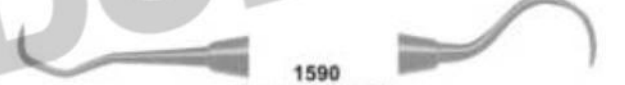

1590  
Jaquette 30-U15



1592  
Jaquette 30-33

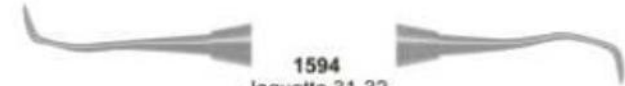

1594  
Jaquette 31-32



1596  
Jaquette 33-H5



1598  
U 6-7



1600  
128L

## Explorers

### Explorers Double Ended - Octagonal

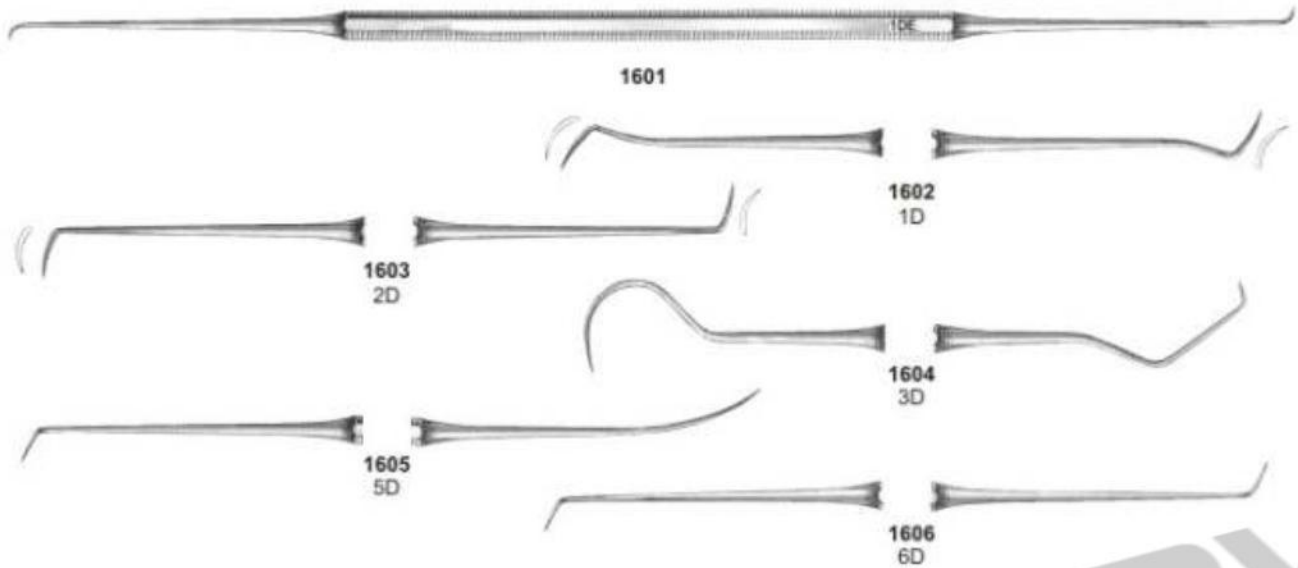

### Explorers Double Ended - Standard

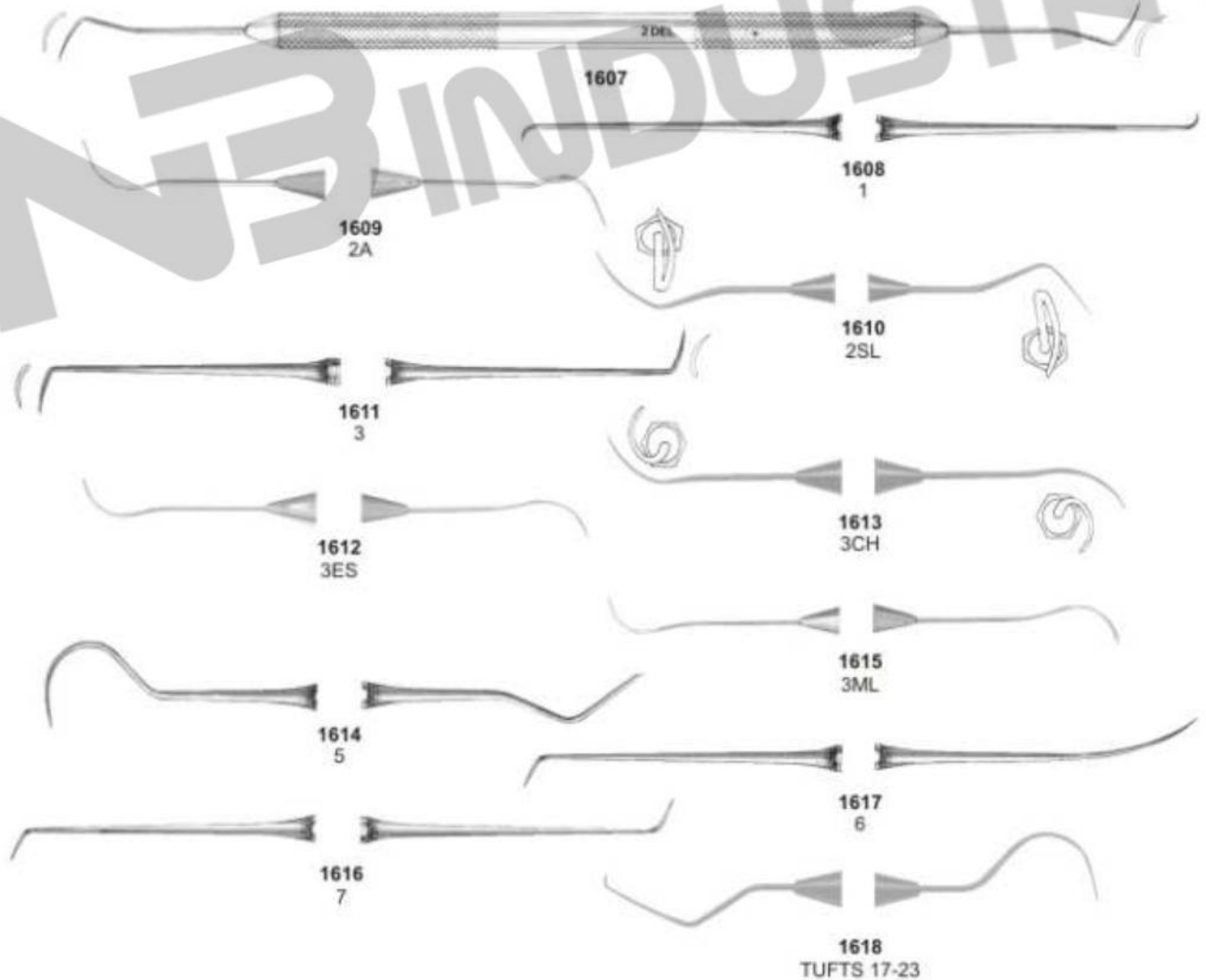

## Explorers

### Explorers Double Ended Tactile Tone



1619  
2A



1620  
2



1621  
1



1622  
2SL



1623  
3



1624  
3CH



1625  
3ES



1626  
3ML



1627  
5



1628  
6



1629  
7



1630  
16



1631  
TUFTS 17/23



## Explorers & Probes

### Explorers Single Ended - Octagonal

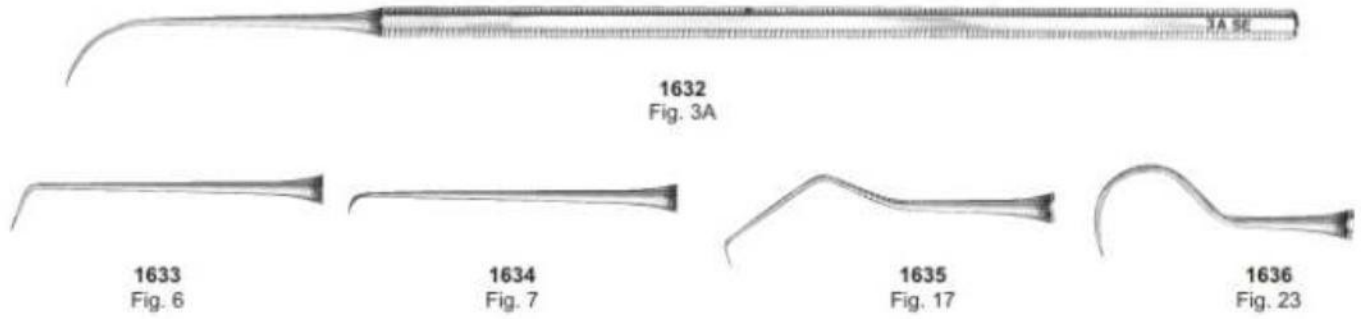

### Explorers Single Ended - Standard

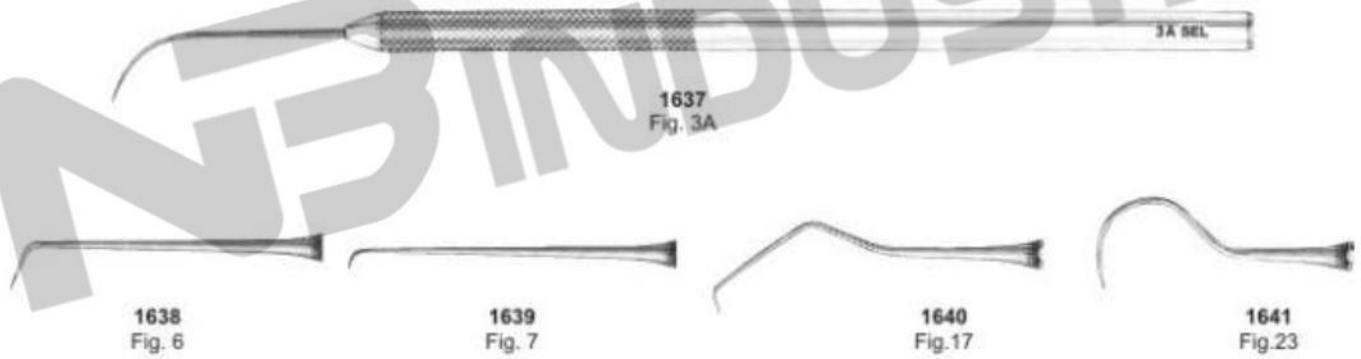

### Probe / Explorer - Octagonal



### Double Ended Probe - Octagonal

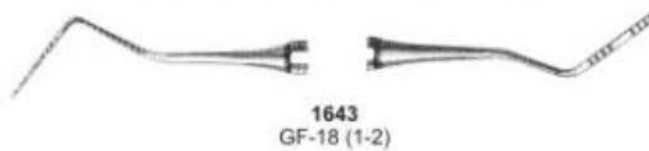

## Probes

### Probes Double Ended - Standard

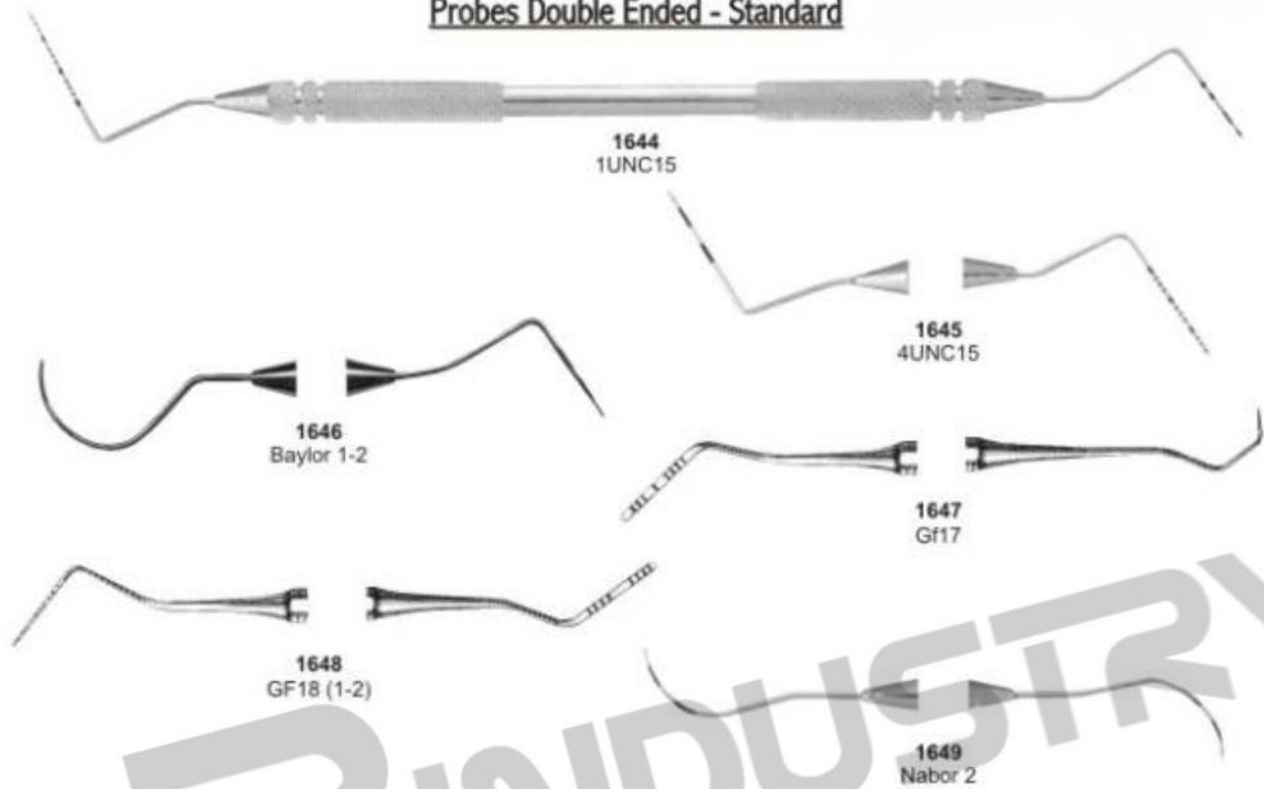

### Probes Double Ended - Tactile Tone

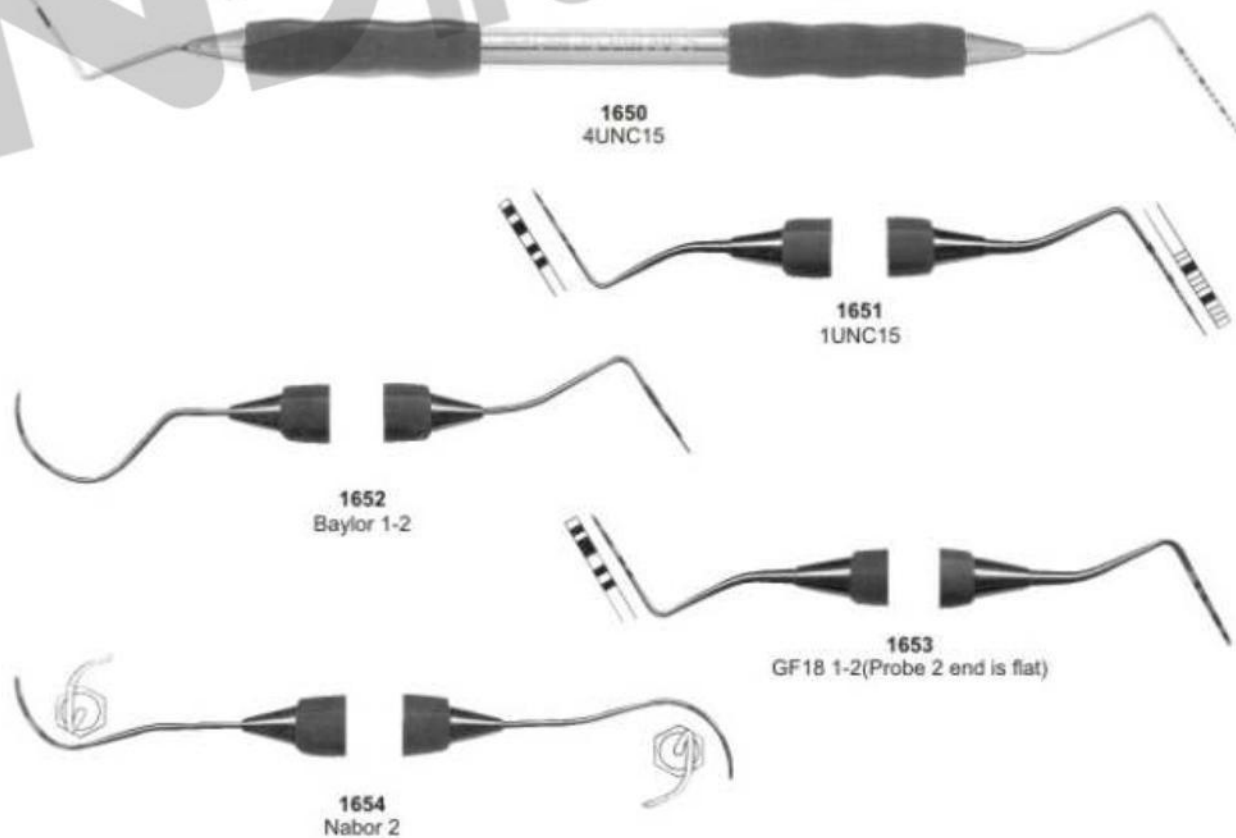

## Probes

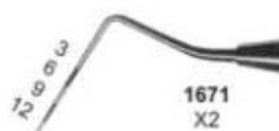
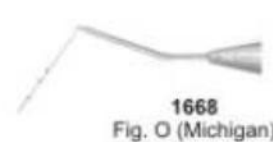
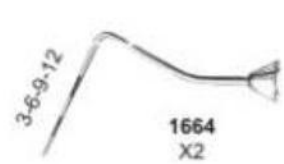
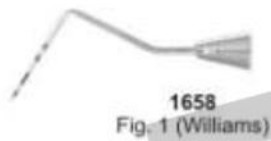
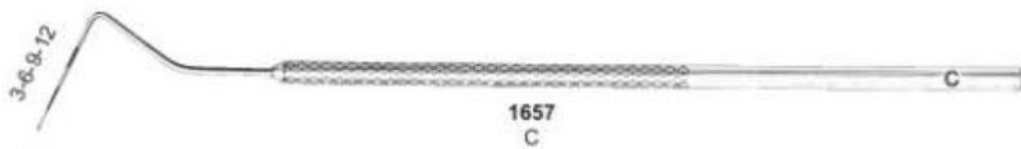
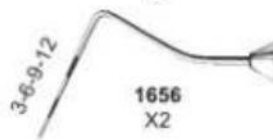
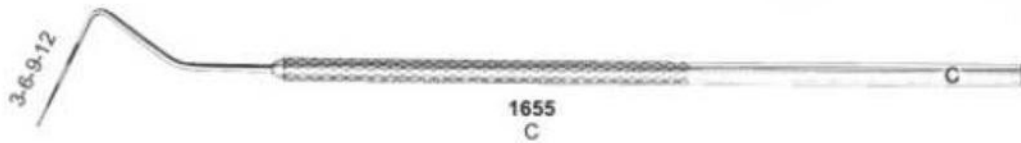

## Probes

### PROBES DOUBLE ENDED STANDARD

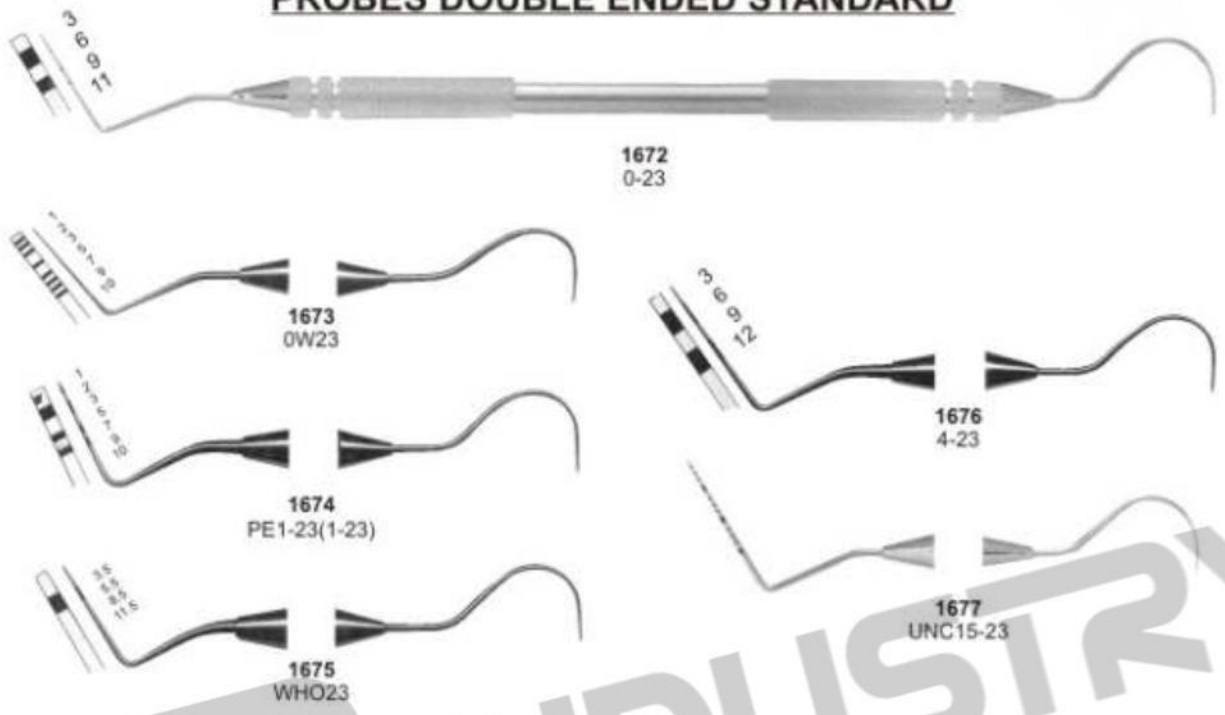

### PROBES DOUBLE ENDED TACTILE TONE

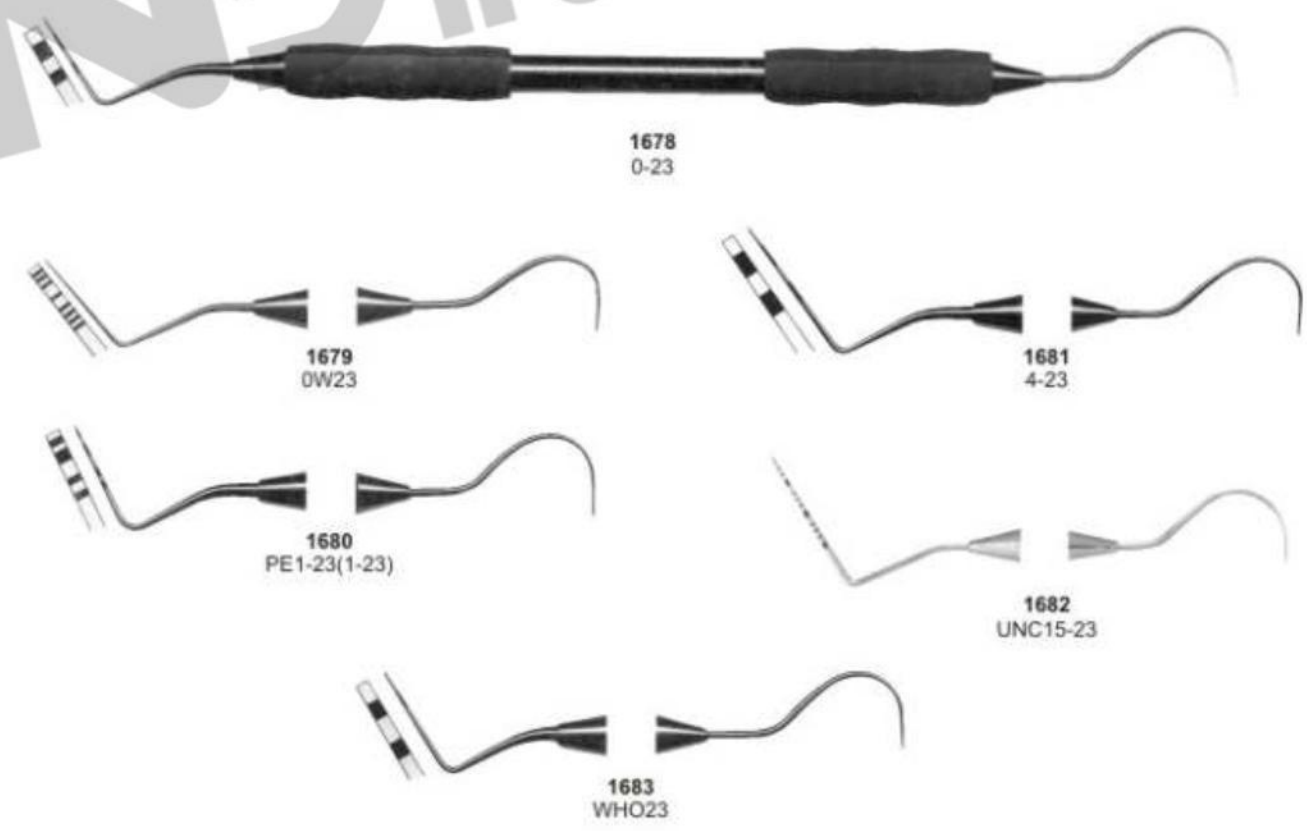



## Endodontic Condensers

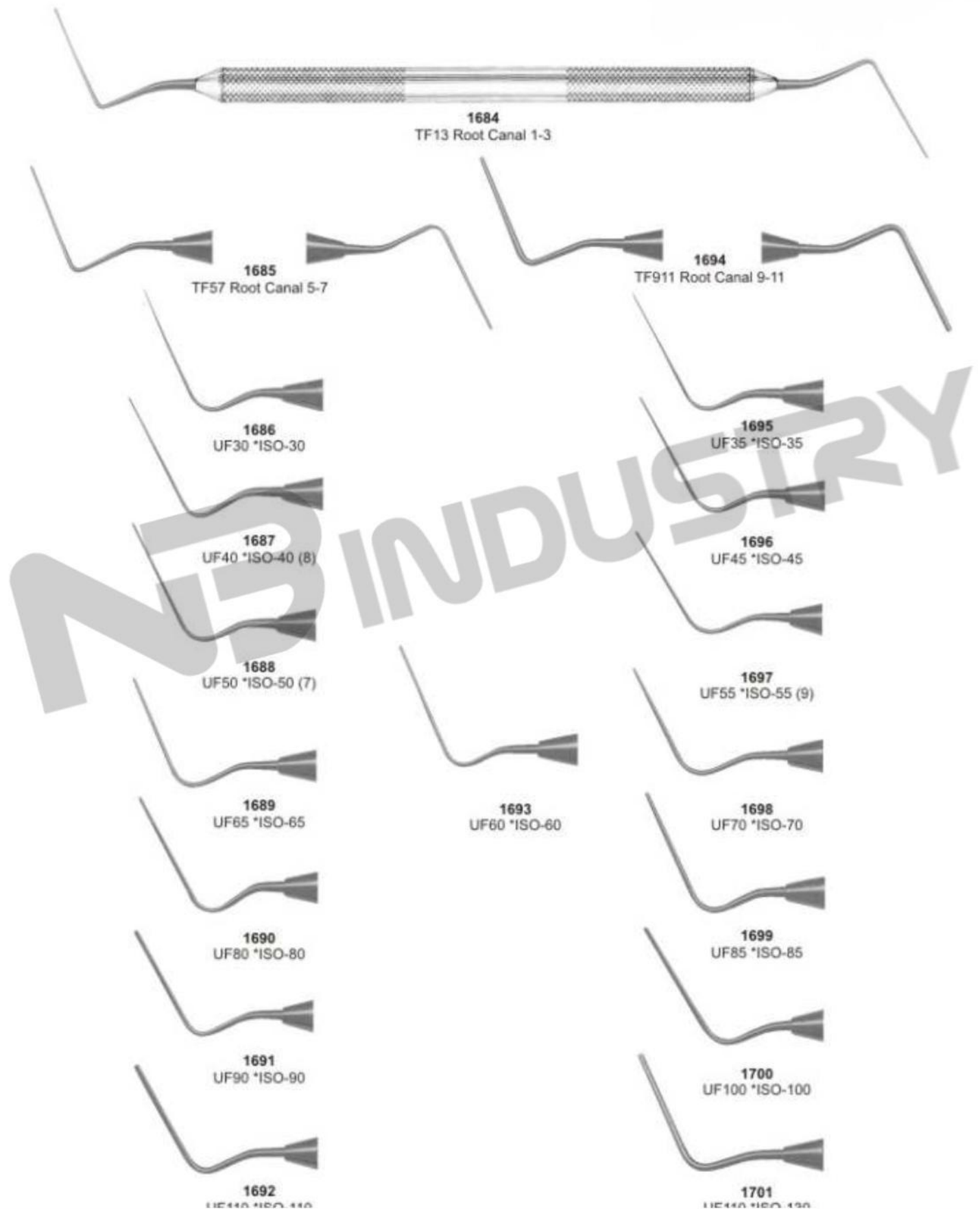

## Endodontic Condensers/Spreaders



1702  
UF120X



1703  
UF45N



1704  
UF60N



1705  
UF80N



1706  
UF100X



1707  
UE25 R-25



1708  
UE30 R-30



1709  
UE35 R-35



1710  
UE40 R-40



1711  
UE45 R-45



1712  
UE50 R-50



1713  
UF120X



1714  
UF140X



1715  
TFD3545N



1716  
TFD6080N



1717  
UE55 R-55



1718  
UE60 R-60



1719  
UE25N R-25



1720  
UE30N R-30



1721  
UE40N R-40

## Obturation Instruments

**1722**  
No. D11



**1723**  
No. D11T



**1724**  
No. KR1



**1725**  
No. 25S

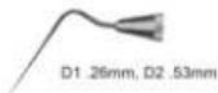

**1726**  
No. W1S



**1727**  
No. W2S

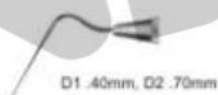

**1728**  
Lucks No.1



**1729**  
Lucks No.2



**1730**  
Lucks No.3



**1731**  
Lucks No.4



**1732**

No. 5, D(1mm).50mm, .55mm D(5mm)  
D(16mm), 85mm, .75mm D(16mm)

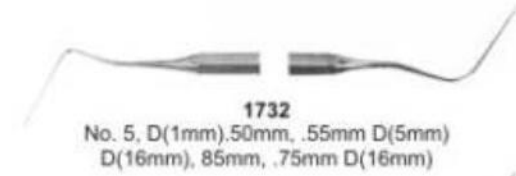

**1733**

No. 7, D(1mm).70mm, .50mm D(5mm)  
D(16mm), 1.00mm, .75mm D(16mm)

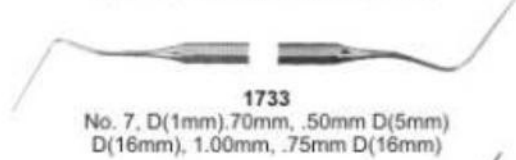

**1734**

No. 9, D(1mm)1.00mm, .63mm D(5mm)  
D(16mm), 1.30mm, .75mm D(16mm)

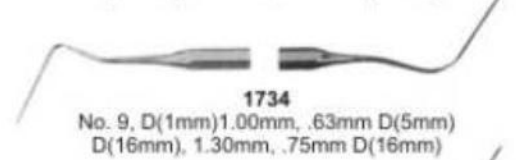

**1735**

No. 11, D(1mm)1.20mm, .63mm D(5mm)  
D(16mm), 1.50mm, .75mm D(16mm)

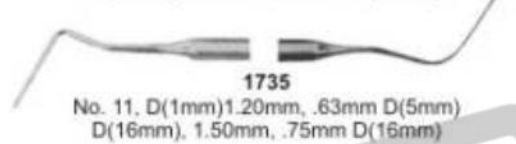

**1736**

No.1 (D1 .35mm, D16 .75mm)



**1737**

No.2 D1 .55mm, D16 .85mm



**1738**

No.3 D1 .85mm, D16 1.15mm



**1739**

No.4 D1 1.00mm, D16 1.30mm



**1740**

No.1-3 - D1 .25mm/D1 .35mm



**1741**

No.3-5 - D1 .35mm/D1 .55mm



**1742**

No.5-7 - D1 .55mm/D1 .70mm

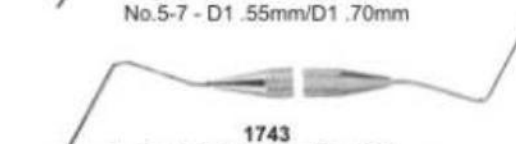

**1743**

No.9-11 - D1 1.00mm/D1 1.20mm



## Excavators

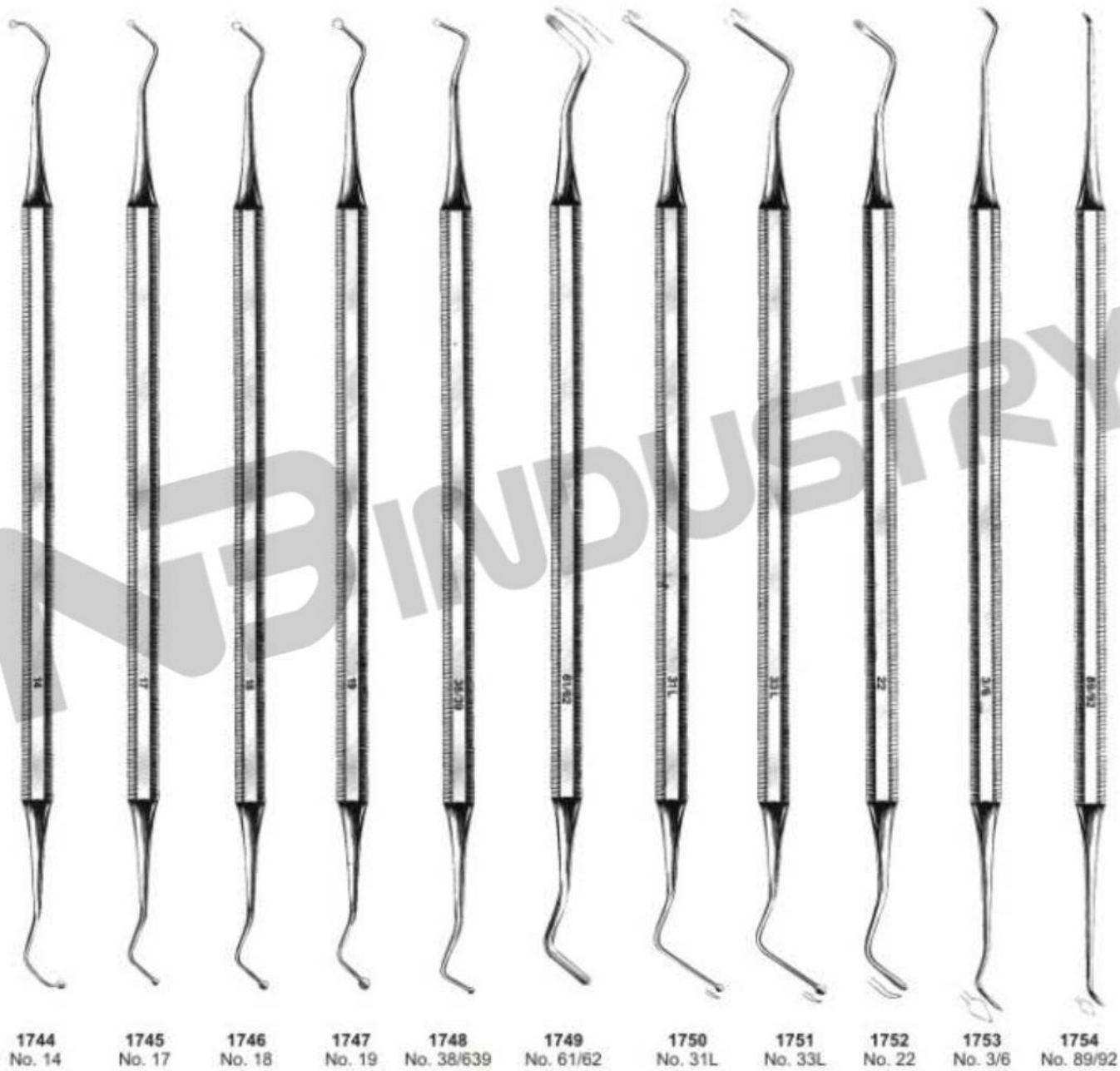

1744  
No. 14

1745  
No. 17

1746  
No. 18

1747  
No. 19

1748  
No. 38/639

1749  
No. 61/62

1750  
No. 31L

1751  
No. 33L

1752  
No. 22

1753  
No. 3/6

1754  
No. 89/92



## Excavators



**1755**  
1mm Discoid (10-7-14)



**1756**  
1mm Discoid (38-39) (11.5-7-14)



**1757**  
E2 Discoid (15-9-15)



**1758**  
1.5mm Discoid (15-8-14)



**1759**  
E3 Discoid (25-9-15)



**1760**  
2mm Discoid (20-9-14)



**1761**  
1.5mm Spoon (15-8-14)



**1762**  
E1 Discoid (12-9-15)



**1763**  
2mm Spoon (20-9-14)



**1764**  
17 Tear-Drop



**1765**  
19 Tear-Drop



**1766**  
18 Tear-Drop



**1767**  
20 Tear-Drop



## Excavators, Explorer / Probes

### Excavators

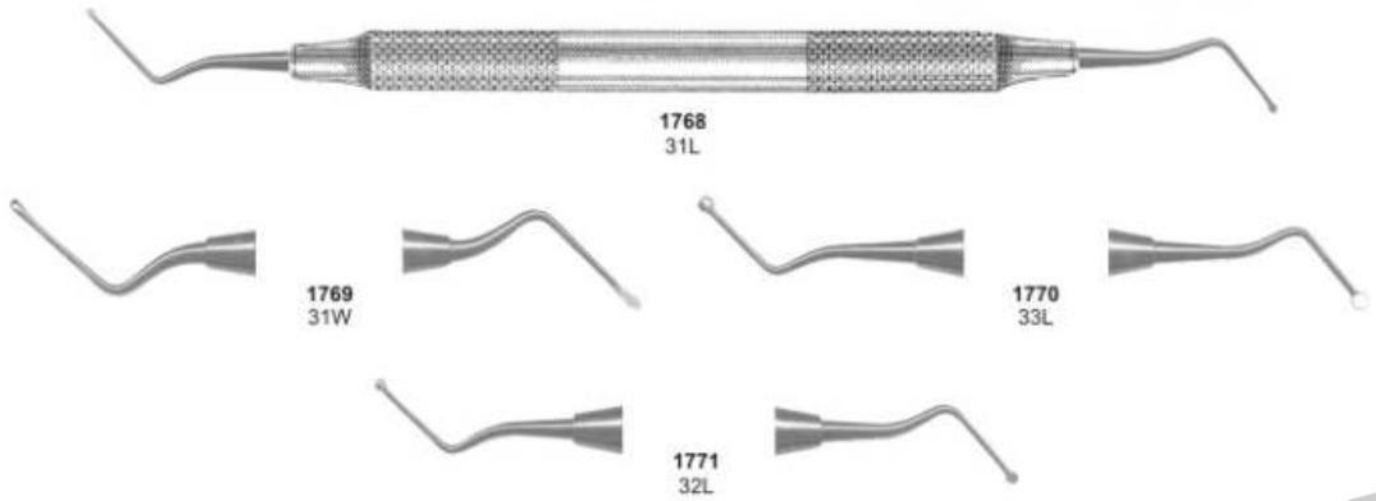

### Explorers / Probes

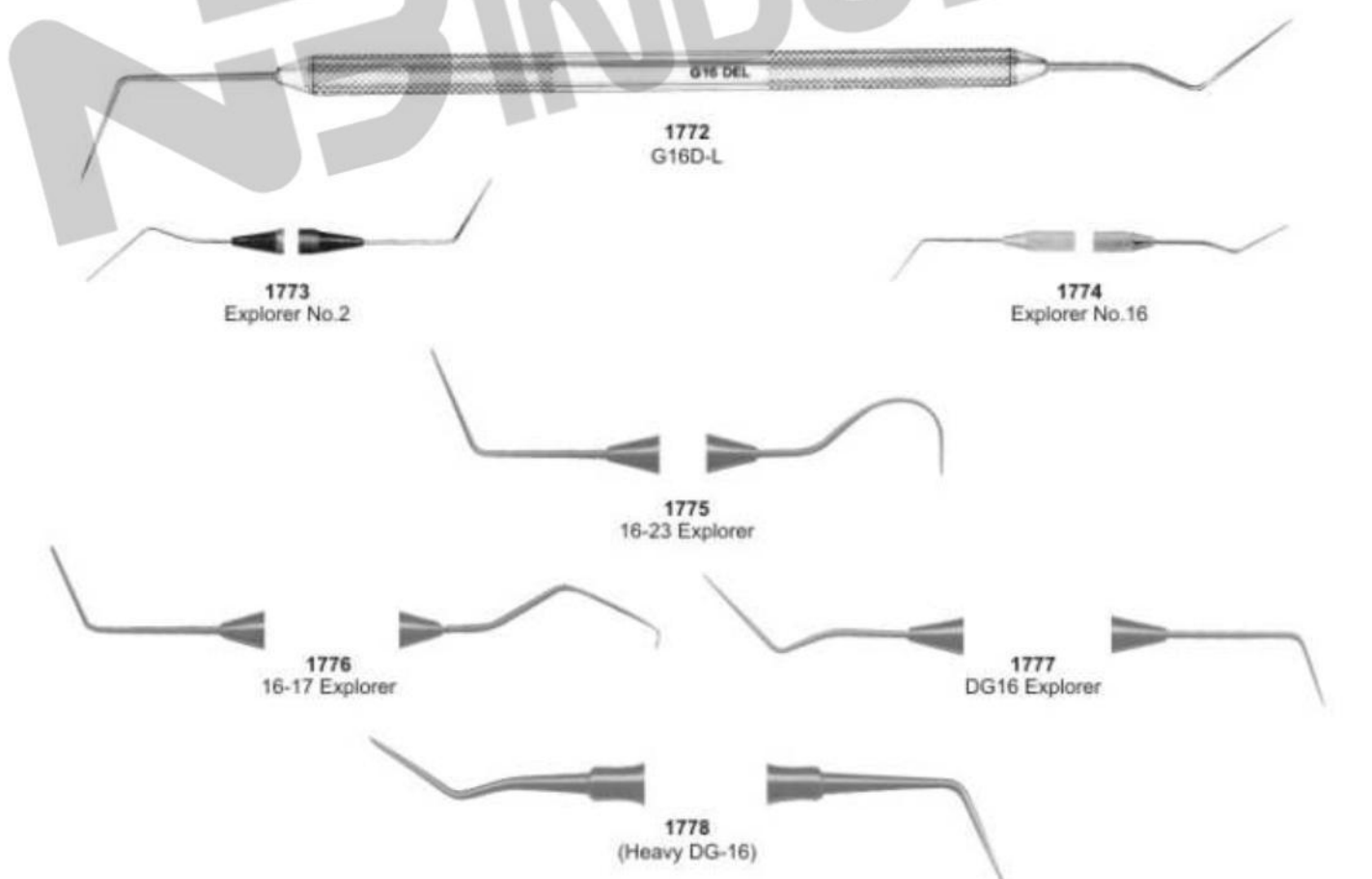

## Explorers



1779  
1D

1780  
2D

1781  
3D

1782  
5D

1783  
6D

1784  
7D

1785  
3A-S

1786  
6S

1787  
7S

1788  
17S

1789  
23S

## Explorers





## Explorer / Probe Combination

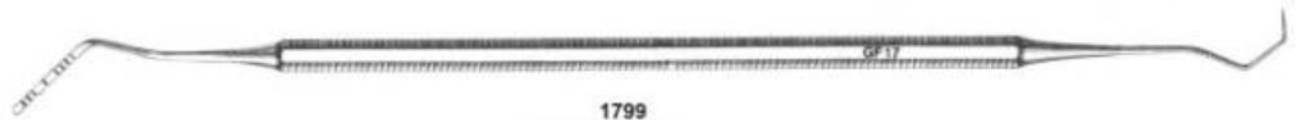

**1799**  
Gf17 Probe/Explorer



**1800**  
PE 1-23 Probe/Explorer

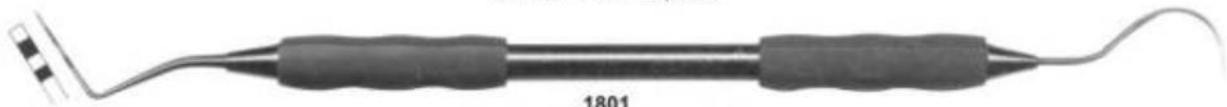

**1801**  
Probe 0 / 23 Explorer (fine)



**1802**  
Probe 1 / 23 Explorer



**1804**  
Probe 4 / 23 Explorer



**1803**  
Probe OW / 23 Explorer



**1805**  
Ball Tip Probe WHO / 23 Explorer

### PROBES



**1806**  
Gf18 Probe



**1807**  
"C" Probe



**1808**  
X2 Probe



**1809**  
1-2 (Probe 2 end is flat)



**1810**  
1 UNC 15



**1811**  
4 SE

## Cord Packers, Hatchets, Hoes

### CORD PACKERS



1812

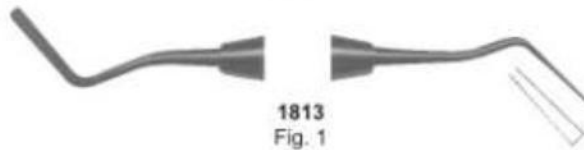

1813  
Fig. 1



1814  
Fig. 2



1815  
BLOOMFIELD  
Fig. 2 (off angle)



1816  
Fig. 1



1817  
CSI-1 (slightly serrated on ends)



### HATCHETS



1818  
1mm (10-7-14)



1819  
1.3mm (13-10-16)



1820  
1.5mm (15-8-14)

### HOES

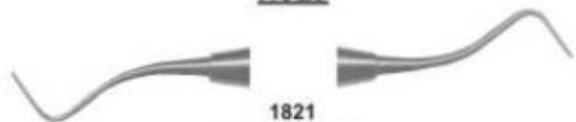

1821  
1mm (10-8-16)



1822  
UWH 18-19



1823  
UWH 16-18



1824  
UWH 20-21

## P.K.Thomas waxing & Gracey Curettes Set



1825  
P.K.Thomas 1



1826  
P.K.Thomas 2



1827  
P.K.Thomas 3



1828  
P.K.Thomas 4



1829  
P.K.Thomas 5



7001  
Gracey Curettes Set of 7 Pcs, Silicon Handle - Reuseable



## Amalgam Pluggers / Condensers / Applicators



1830  
BEHRMAN (Fig. 1)



1831  
BLACK (Fig. 1-2)



1832  
MORQUETTE (Fig. 0/1)



1833  
Black Action 11/12 Plugger



1834  
Hollenback No. 1 Plugger



1835  
Hollenback No. 2 Plugger



1836  
Hollenback No. 3 Plugger



1837  
Blacks 0-1 (1mm-1.5mm)



1838  
Blacks 1-2 (1.5mm-2.5mm)



1843  
.7mm-1mm



1844  
1mm-1.5mm



1839  
Bodkin 1 (.7mm-1mm)



1840  
Bodkin 2 (1.5mm-2mm)



1845  
1.5mm-2mm



1841  
2.5mm-3mm

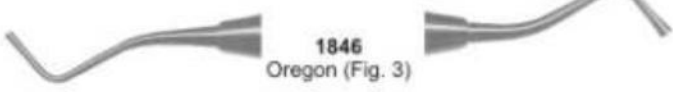

1846  
Oregon (Fig. 3)



1842  
Oregon 2



1847  
Oregon (Fig. 4)



1848  
UP 12



1849  
Applicator 1-2



1850  
Birtles Applicator Spatula



1851  
Birtles Applicator Spatula K



## Placement Instruments, Stopping Stoppers, Plugg

### Placement Instruments



1852  
PICH (Calcium Hydroxide Placer)



1853  
CA

### Stopping Stoppers



1854  
Woodson 2

Ø 1.6 mm

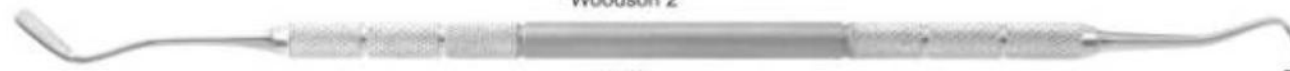

1855  
Woodson 3S

Ø 2.4 mm

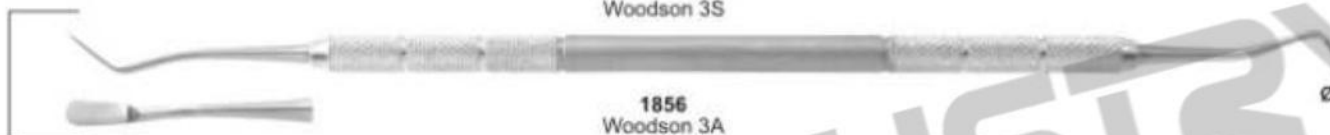

1856  
Woodson 3A

Ø 2.6 mm



1857  
Woodson 3

Ø 3.0 mm

### Pluggers

Ø 0.75 mm



1858  
Pluggers 0-1

Ø 1.2 mm

Ø 1.2 mm



1859  
Pluggers 1-4

Ø 1.6 mm

Ø 1.6 mm



1860  
Pluggers 4-6

Ø 2.0 mm

Ø 2.0 mm



1861  
Pluggers 6-8

Ø 2.5 mm

Ø 1.5 mm



1862  
Black 1-2

Ø 2.6 mm

Ø 3.6 mm



1863  
Black 2-3

Ø 5.0 mm

## Section - 03

- \* Burnishers \* Carvers \* Chisels
- \* Composite Placements
- \* Filling Instruments \* Curettes
- \* Disposable Instruments



## Burnishers



1864  
Fig. 1



1865  
Fig. 28/29



1866  
Fig. 34



1867  
Fig. 27/29



1868  
Fig. 21B



1869  
ACORN  
Fig. 21



## Burnishers

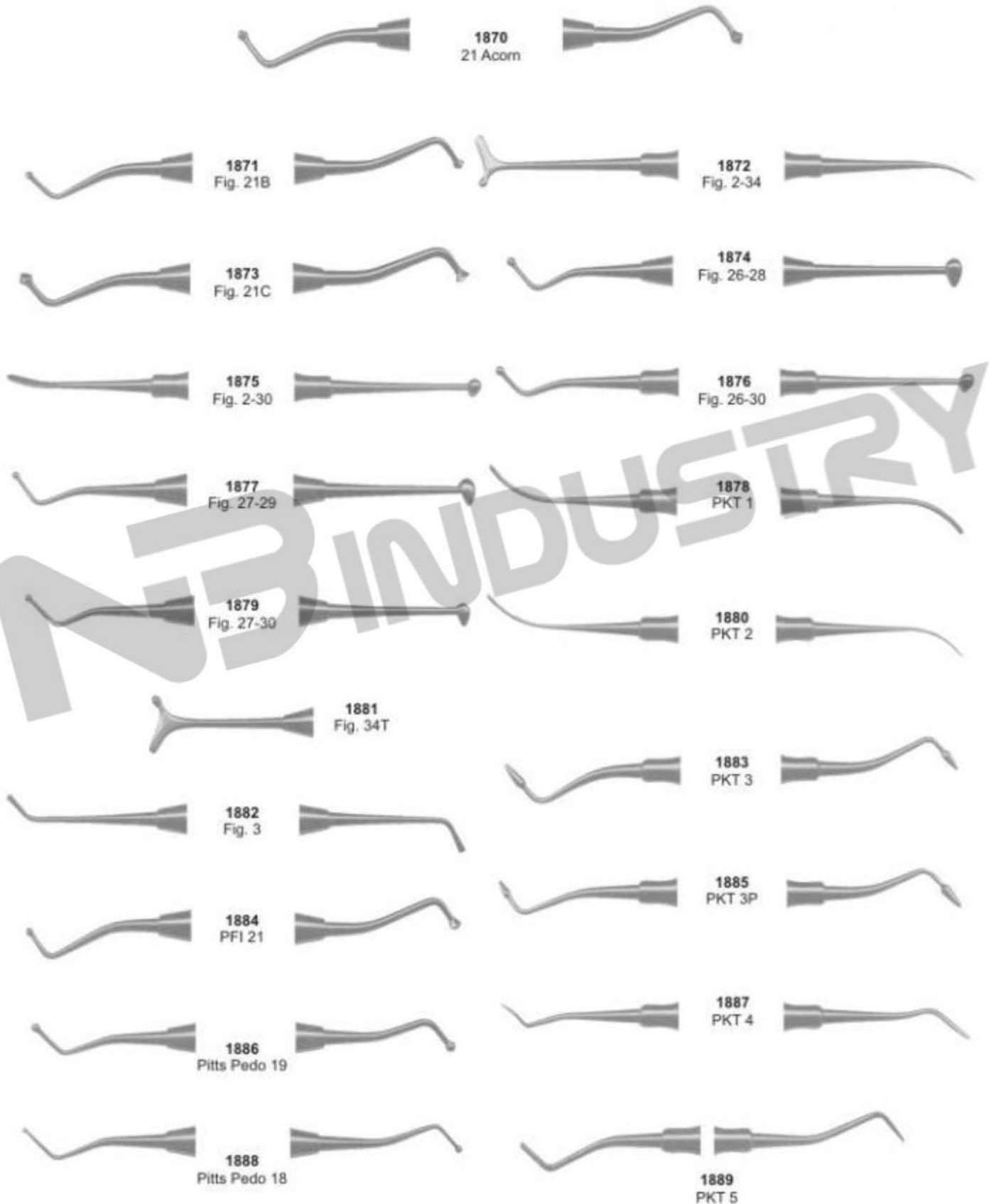



## Wax Carvers



## Carvers



**1898**  
1.5mm Cleoid Discoid (Shown with GTX Finish)



**1899**  
2mm Cleoid Discoid



**1901**  
3mm Cleoid Discoid



**1900**  
GOLLOBIN  
Fig. 1



**1902**  
HOLLOWBACK  
Fig. 1/2



**1903**  
FRAHM  
Fig. 2-3 (off-angle)



**1904**  
HOLLOWBACK  
Fig. 3



**1905**  
Interproximal 1



**1906**  
THOMPSON (Fig. 3)  
( $\frac{1}{2}$  Hollenback Hoe & Wall 3)



**1908**  
THOMPSON (Fig. 5)  
( $\frac{1}{2}$  Hollenback Hoe & Tanner 5)



**1907**  
Interproximal 1



**1910**  
THOMPSON (Fig. 8)  
(3mm Cleoid & Wall 3)



**1909**  
Baum Interproximal



**1912**  
THOMPSON (Fig. 9)  
(Hollenback 3 & Wall 3)



**1911**  
Sho A Carver



**1913**  
Thompson 2



**1914**  
WARD  
Fig. 2

## Carvers, Chisels



**1915**  
Composite Interproximal



**1916**  
TANNER  
Fig. 5



**1917**  
TANNER  
Fig. 6



**1920**  
University of Minnesota  
Fig. 1



**1921**  
University of Minnesota  
Fig. 2



**1918**  
THARP  
Fig. 1



**1919**  
THOMPSON  
Fig. 1



**1922**  
UPR  
Fig. 1



**1923**  
WALL  
Fig. 3

### Contour Carbide Carvers - Finishing



**1924**  
Contour Carbide (Fig. 1-2)



**1925**  
Cleoid Discoid



**1926**  
Contour Carbide (Fig. 10-11)

### Chisels



**1927**  
1.5mm Bin-Angle (15-8-8)



**1928**  
1.5mm Straight (15)



**1930**  
1.5mm Wedelstaedt (15-15-3)



**1929**  
1mm Wedelstaedt (10-15-3)



**1931**  
2mm Wedelstaedt (20-15-3)

## Composite Placement

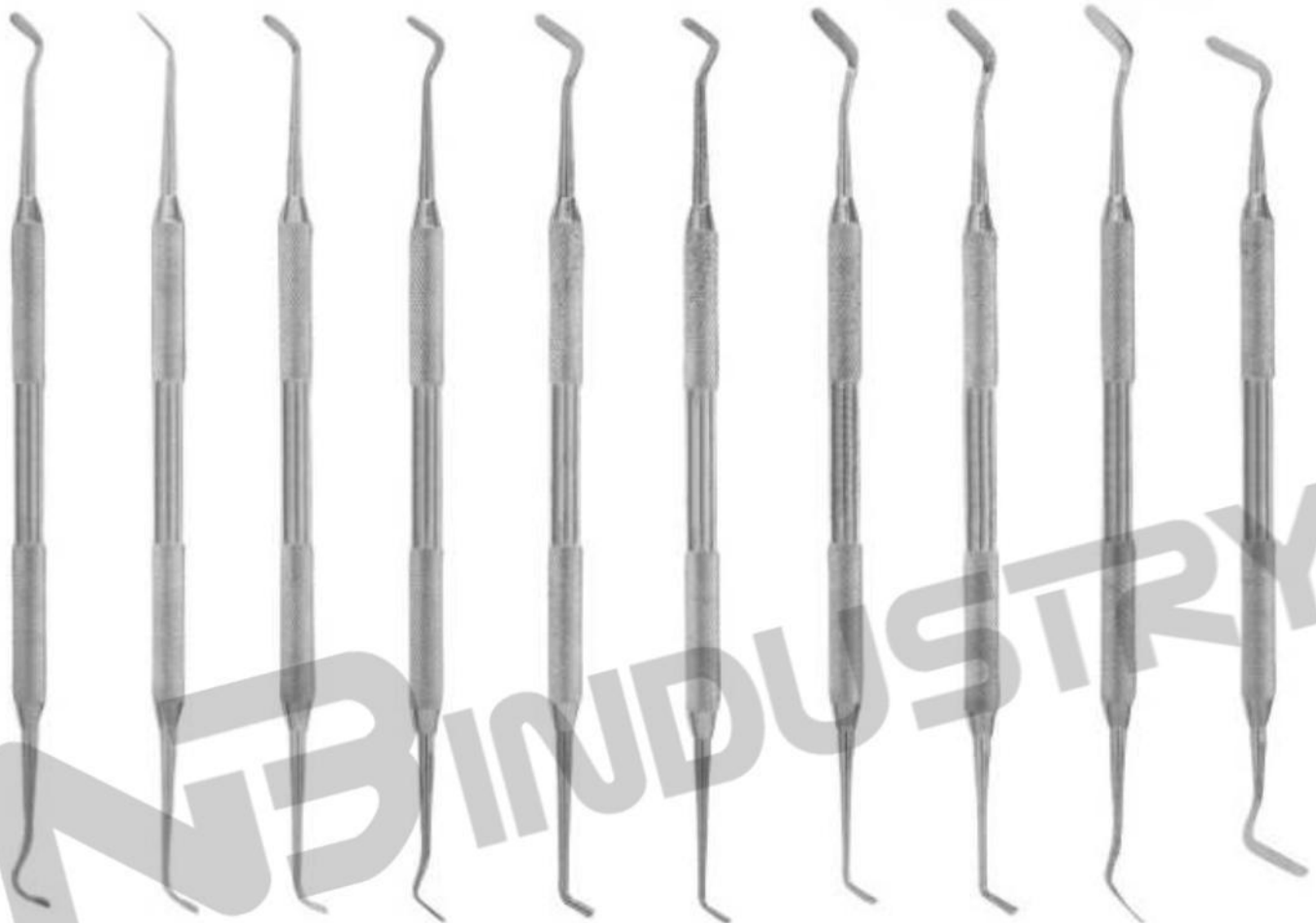

1932  
F-Type 1

1933  
F-Type 2

1934  
F-Type 3

1935  
F-Type 4

1936  
F-Type 5

1937  
F-Type 6

1938  
G-Type 1

1939  
G-Type 2

1940  
G-Type 3

1941  
G-Type 4

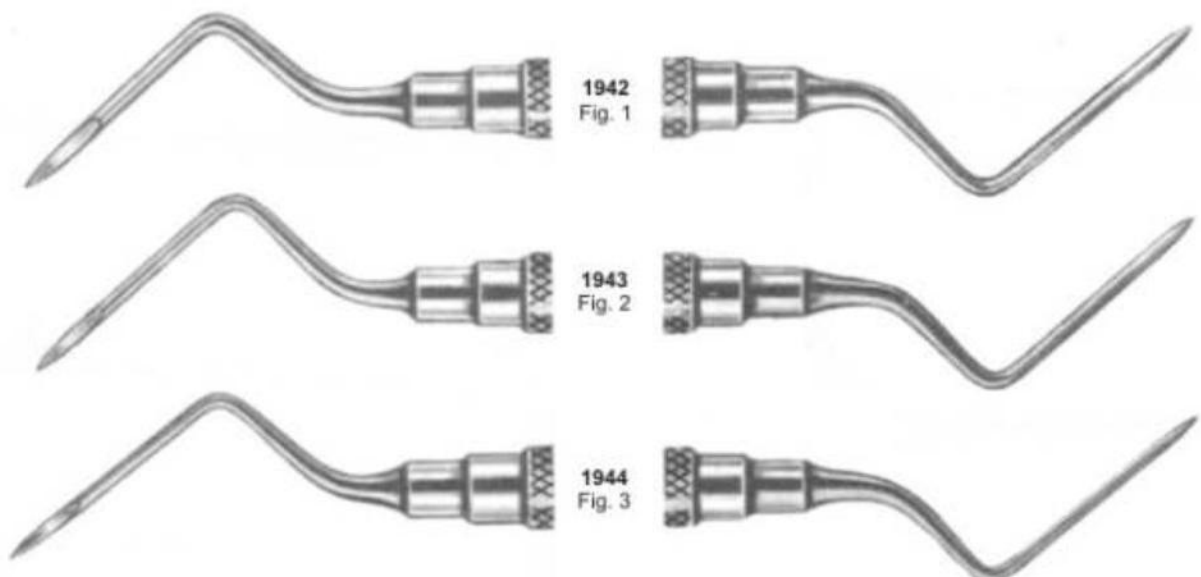

1942  
Fig. 1

1943  
Fig. 2

1944  
Fig. 3



## Composite Placement



1945  
Fig. 2



1946  
Fig. 3 (off-set blade)



1954  
Fig.12



1947  
Fig. 4



1955  
Fig.15



1948  
Fig. 5



1956  
JORDAN  
Fig. 2



1949  
Fig. 6



1957  
FREEDMAN  
Fig. 1



1950  
Fig.7



1958  
FREEDMAN  
Fig. 2



1951  
Fig.8



1959  
FREEDMAN  
Fig. 3



1952  
Fig.9



1960  
Dr. Dan



1953  
Fig.11



1961  
SIMON  
Fig. 2



### K - Type

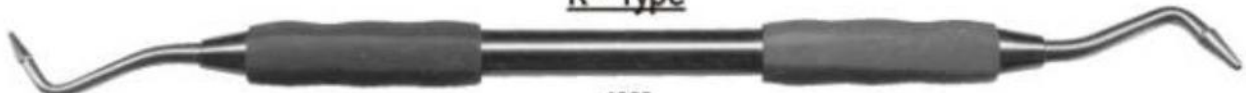

1962  
K-Type 1



1963  
K-Type 2



1965  
K-Type 4



1964  
K-Type 3



1966  
K-Type 5



1967  
K-Type 6 Carbide

## Plastic Filling Instruments



1968  
No.3

1969  
No.4

1970  
No.5

1971  
LADMORE  
Fig. 3

1972  
WOODSON  
Fig. 1

1973  
WOODSON  
Fig. 2

1974  
WOODSON  
Fig. 3

1975  
W-3

1976  
Gregg  
4/5

## Plastic Filling Instruments



1977  
Fig. 5-7



1978  
Fig.1



1979  
Fig. 3

1983  
GLICK  
Fig.1



1980  
Fig. 4

1984  
P8



1981  
Fig. 5-7

1985  
WOODSON  
Fig. 1



1982  
Fig. 8A

1986  
WOODSON  
Fig. 2



1987  
WOODSON  
Fig. 3

## Curettes

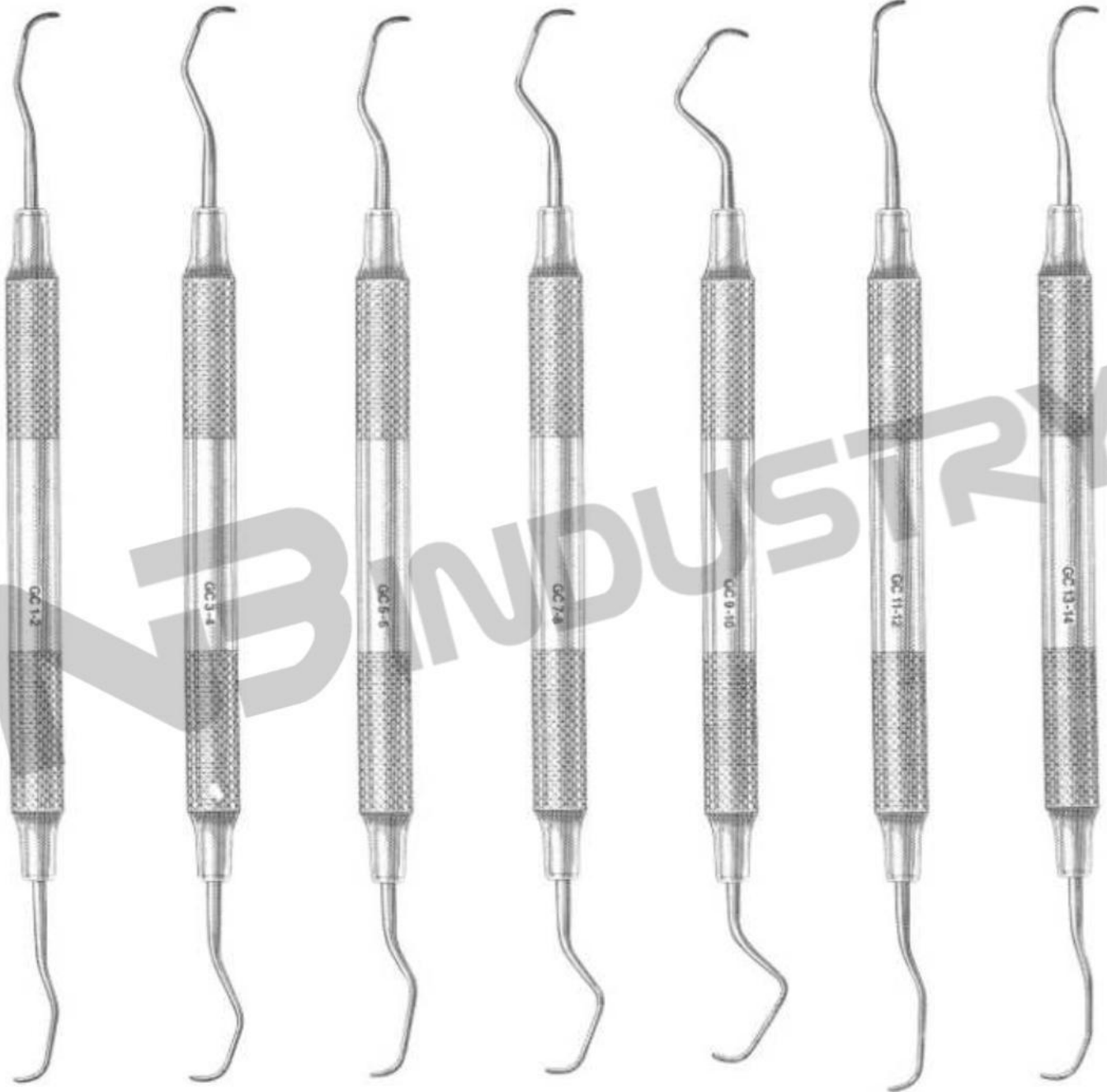

1988  
GRACEY  
GC 1-2

1989  
GRACEY  
GC 3-4

1990  
GRACEY  
GC 5-6

1991  
GRACEY  
GC 7-8

1992  
GRACEY  
GC 9-10

1993  
GRACEY  
GC 11-12

1994  
GRACEY  
GC 13-14



## Gracey Currettes



1995  
G1-2

1996  
G3-4

1997  
G5-6

1998  
G7-8

1999  
G9-10

2000  
G11-12

2001  
G13-14

## Curettes # 4 Handle

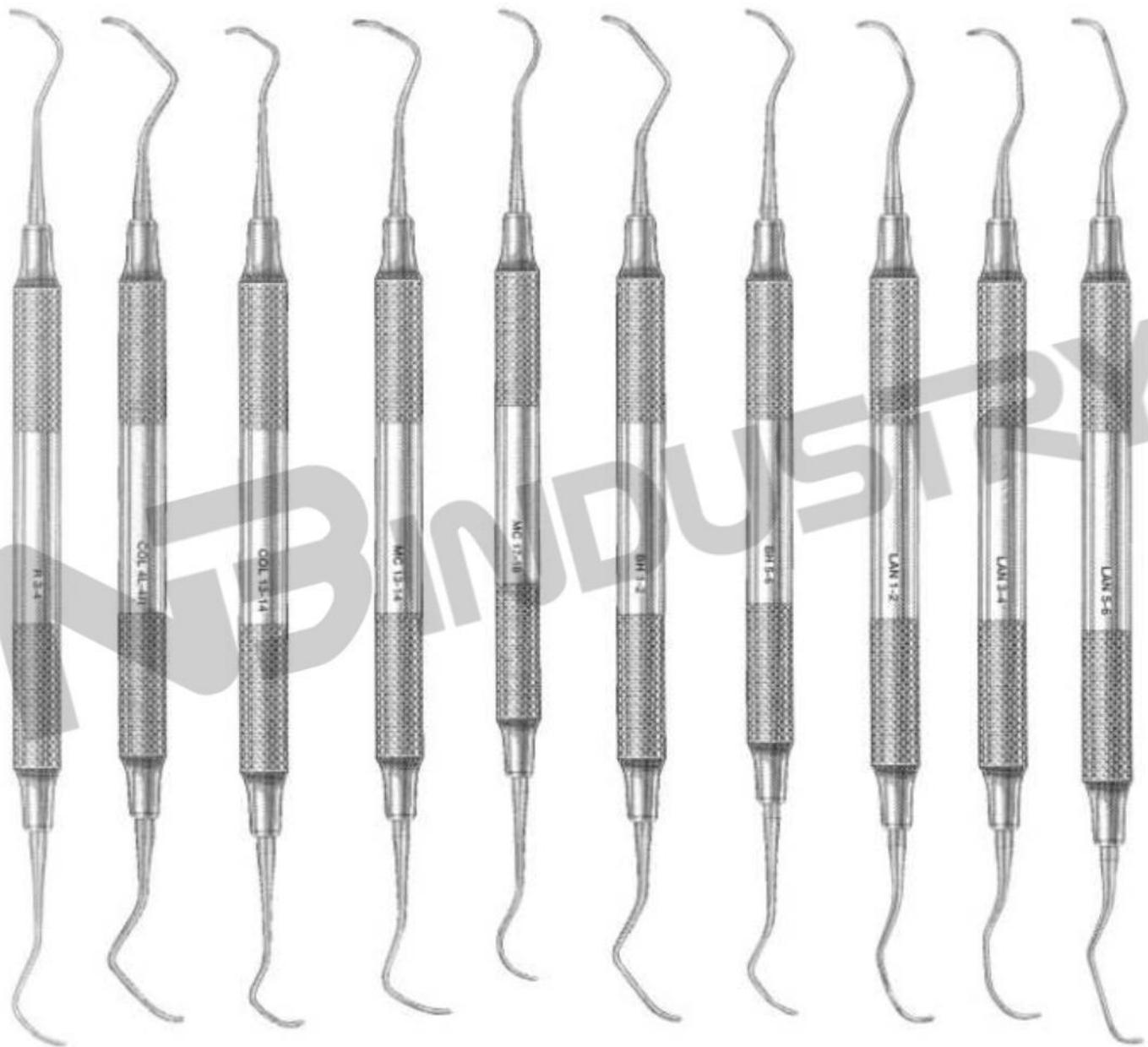

2002  
RULE  
3-4

2003  
COLUMBIA  
4R-4L

2004  
COLUMBIA  
13-14

2005  
MCCALLS  
13-14

2006  
MCCALLS  
17-18

2007  
BARNHART  
1-2

2008  
BARNHART  
5-6

2009  
LANGER  
1-2

2010  
LANGER  
3-4

2011  
LANGER  
5-6

## Curettes

### COLUMBIA CURETTES



2012  
4L-4R

2013  
13-14

2014  
2L-2R

### MCCALLS CURETTES



2015  
13-14

2016  
13S-14S

2017  
17-18

2018  
17S-18S

## Curettes

### GOLDMAN FOX



2019  
GF1 Universal Scaler



2020  
GF2 Curette



2021  
GF3 Curette



2022  
GF4 Curette



2023  
GF5 Hoe



2024  
GF6 Hoe



## Curettes

### GOLDMAN FOX



2025  
GF 7 Knife



2026  
GF 8 Spear Knife



2027  
GF 9 Knife Scaler



2028  
GF 11 Spear Knife



2029  
GF 21 Sharp Spoon /  
Small Scaler

## Knives, Interproximal Files



2030  
Kirkland 15 / 16



2031  
Ordan 1 / 2



2032  
Buck 3 / 4

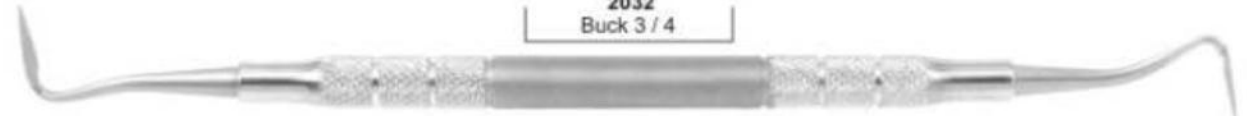

2033  
Buck 5 / 6



2034  
Goldman-Fox 7



2035  
Goldman-Fox 8



2036  
Goldman-Fox 9



2037  
Goldman-Fox 11



2038  
CK 3 (Crane)

### Interproximal Files



2039  
Sugarman 1S-2S



2040  
Sugarman 3S-4S



2041  
Schluger 9 -10



2042  
Buck 11 - 12

## Curettes, Root Planning Curettes



2043  
COLUMBIA (2L-2R)



2044  
MCCALL (13-14)



2045  
MCCALL (17S-18S)

### Root Planning Curettes



2046  
Root Plane (1-2)



2047  
Root Plane (5-6)



2049  
Root Plane (11-12)



2048  
Root Plane (7-8)



2050  
Root Plane (13-14)



2051  
Petite (1-2)



2052  
Petite (11-12)



2053  
Petite (5-6)



2054  
Petite (13-14)

## Curettes



2055  
BARNHART (1-2)



2056  
BARNHART (5-6)

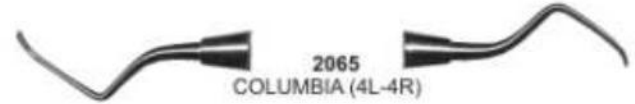

2065  
COLUMBIA (4L-4R)



2057  
GRACEY (1-2)

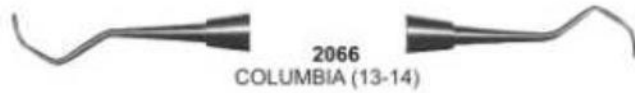

2066  
COLUMBIA (13-14)



2058  
GRACEY (3-4)



2067  
LANGER (1-2)

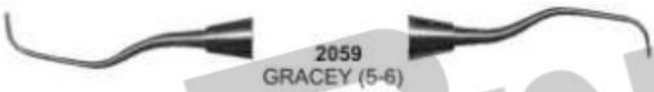

2059  
GRACEY (5-6)



2068  
LANGER (3-4)



2060  
GRACEY (7-8)



2069  
LANGER (5-6)



2061  
GRACEY (9-10)

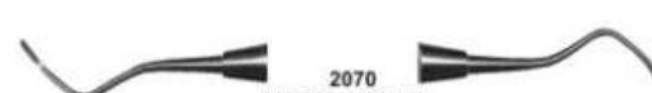

2070  
MCCALL (13-14)



2062  
GRACEY (11-12)



2071  
MCCALL (13S-14S)



2063  
GRACEY (13-14)



2072  
MCCALL (17-18)



2064  
GRACEY (2L-2R)



2073  
MCCALL (17S-18S)



2074  
RULE (3-4)



## Section - 04

- \* Cement Instruments \* Spatulas
- \* Knives \* Bone Currettes & Files
- \* Bone Chisels \* Bone Mallets
- \* Crown Remover
- \* Implant Instruments



## Dental Products

Silicon Handles-Reusable

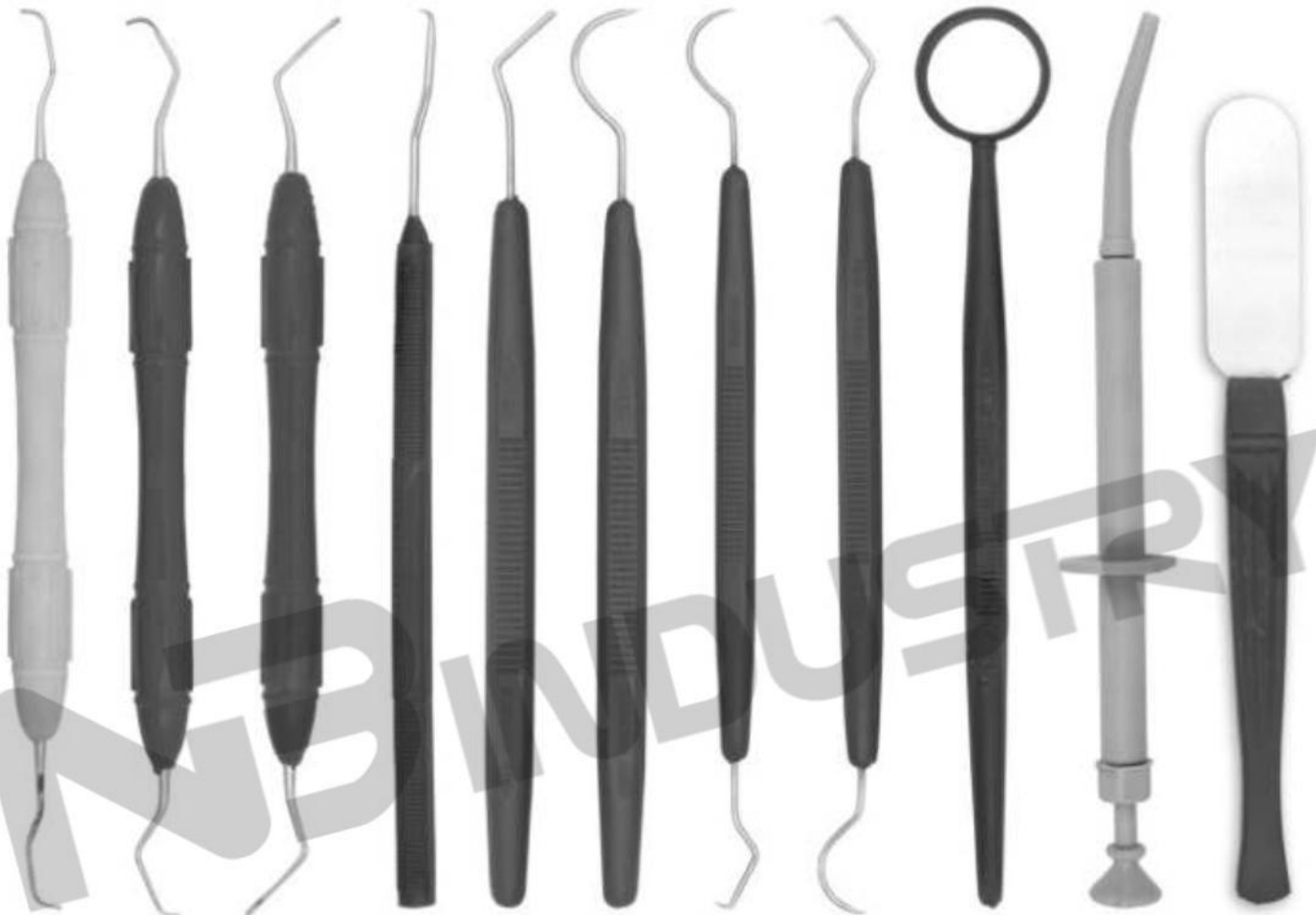

2075

2076

2077

2078

2079

2080

2081

2082

2083

2084

2085



2086

2087

2088

2089

2090

## Wax, Porcelain & Cement Instruments

### Comfort Grip Vinyl - Covered Insulating Handles





## Wax, Porcelain & Cement Instruments

### P.K. THOMAS



2101 PKT 1    2102 PKT 2    2103 PKT 3    2104 PKT 4    2105 PKT 5

Set of 5 instruments

### WAX CARVERS

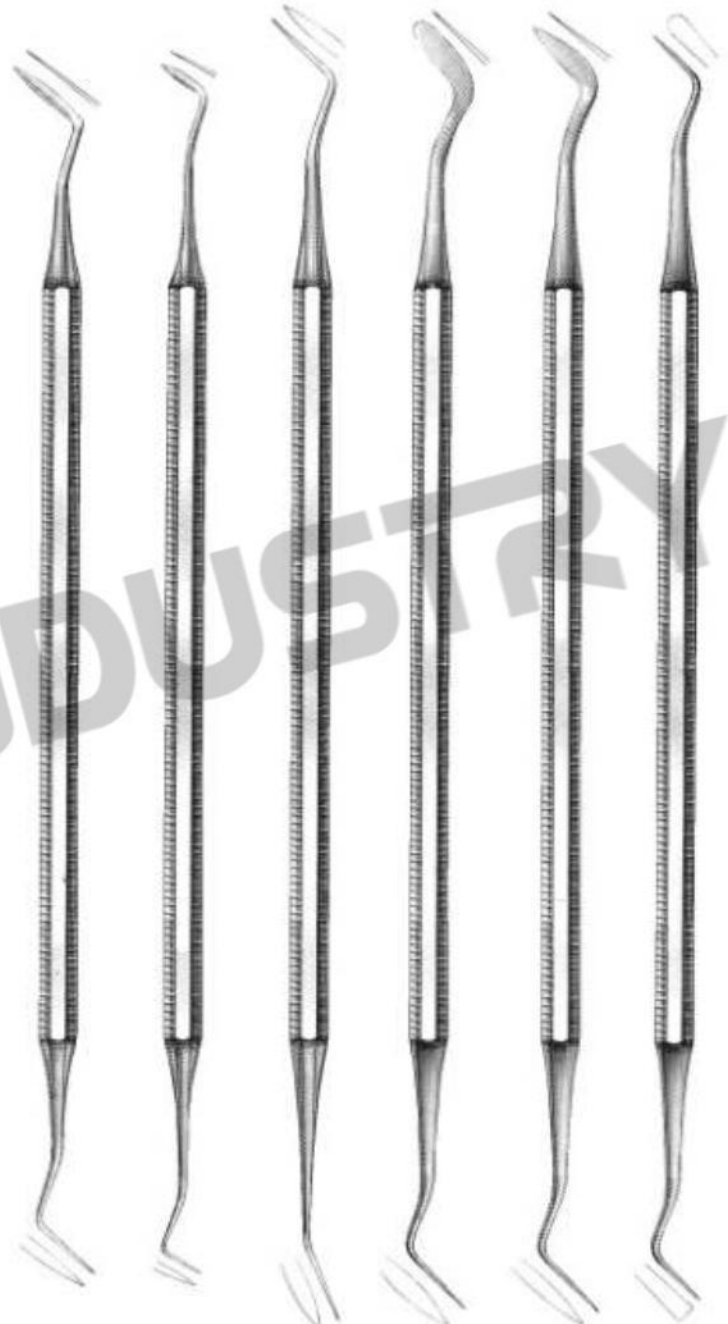

2106 Hollenback 3    2107 Hollenback 3S    2108 WARD 1    2109 WARD 2    2110 WALL 1    2111 WALL 3



## Wax & Modeling Carvers, Cement Spatulas

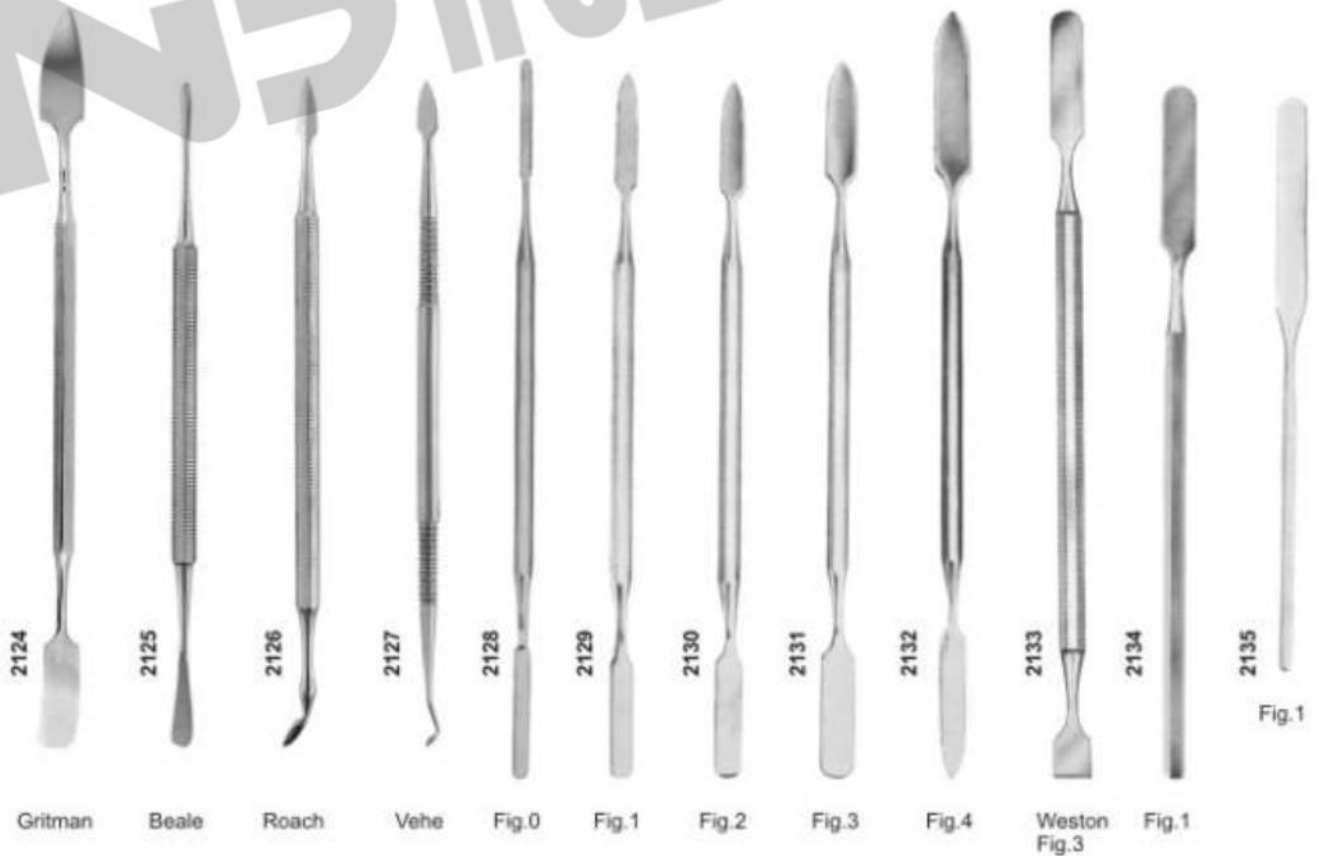

## Wax, Porcelain & Cement Instruments

### WAX & PORCELAIN CARVERS



2136  
LECRON  
Inlay

2137  
REEVES

2138  
VEHE  
Wax

2139  
ROACH  
Wax

### WAX SPATULAS



2140  
W-31

2141  
W-5

2142  
W-7

2143  
W-7A

2144  
W-7G

## Cement Spatulas



2145  
AGATHE

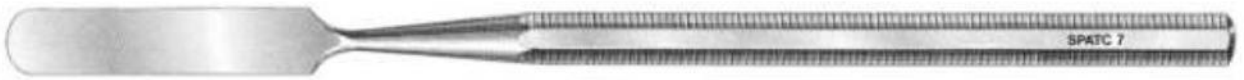

2146  
C-7



2147  
C-5



2148  
C-313



2149  
C-24A Rigid



2150  
C-24 Flexible



2151  
C-24 Flexible



2152  
24



2153  
A6



2154  
7 Wax



2155  
26



2156  
All Metal Spatulas with High Polish  
Stainless Steel Blade



2157  
31





## Spatulas



## Files, Hoes & Knives

### FILES



### HOES



### KNIVES

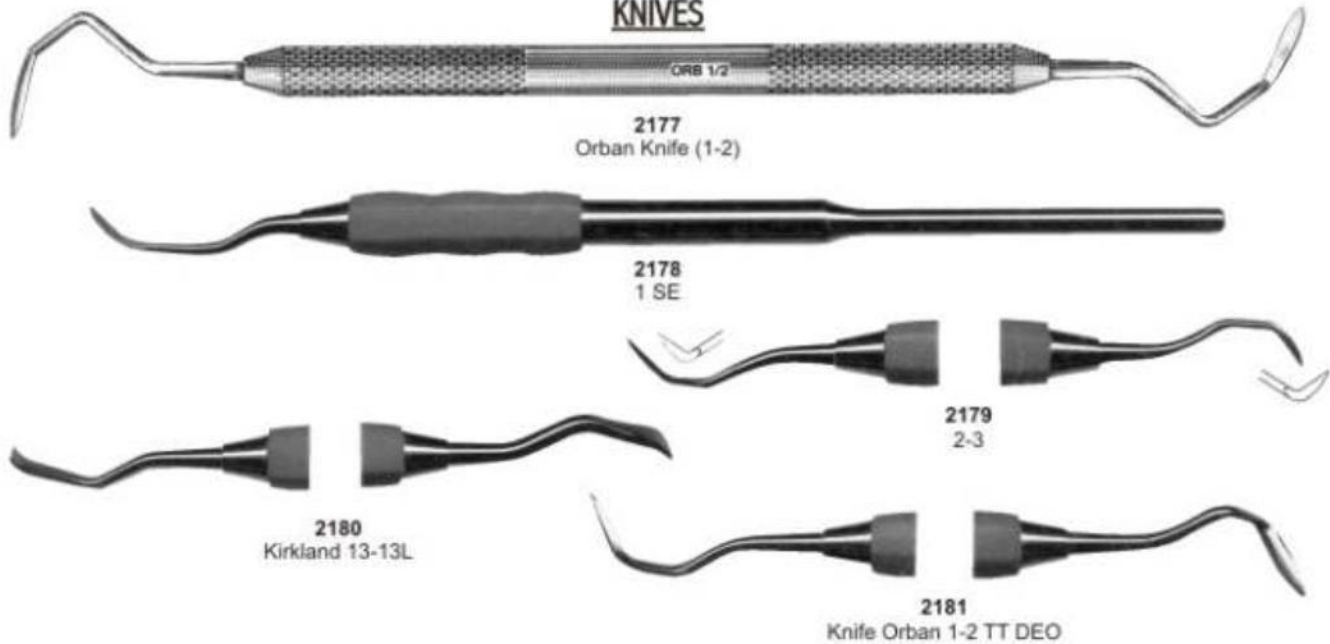

## Wax Knives



**2182**  
Fahnenstock  
Fig. 1  
12,5cm

**2183**  
Fahnenstock  
Fig. 2  
17cm

**2184**  
Lessmann  
Fig. 1  
12,5cm

**2185**  
Lessmann  
Fig. 2  
17cm

**2186**  
Con scodellino  
Fig. 1  
12,5cm

**2187**  
Con scodellino  
Fig. 2  
17cm

**2188**  
Ermert

**2189**  
Ermert

## Wax Knives & Plaster Knives



2190  
18 cm  
7 1/8"



2191  
18 cm  
7 1/8"



2192  
17 cm  
6 3/4"  
Gritman



2193  
17 cm  
6 3/4"  
Medicon



2194  
Fig. 1  
17 cm



2195  
22 cm  
8 3/4"



2196  
22 cm  
8 3/4"



2197  
Gritman  
Fig. 2  
17 cm



2198  
Fig. 3  
16 cm



2199  
Fig. 4  
16 cm



## Crane-Kaplan, Chisels

### CRANE-KAPLAN



2200  
Ck1  
Pocket Marker

2201  
Ck2  
Pocket Marker

2202  
Knife

2203  
Dissector

2204  
Scaler

### OCHSENBEIN



2205  
Ochsenbein  
Fig. 1

2206  
Ochsenbein  
Fig. 2

2207  
Ochsenbein  
Fig. 4

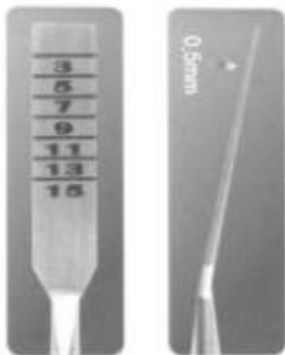

Split Chisel Set



2208  
Split Chisel  
6 mm Curved



2209  
Split Chisel  
6 mm Straight



2210  
Split Chisel  
4 mm Curved



2211  
Split Chisel  
4 mm Straight

## Bone Curettes



## Bone Files



## Bone Files



2224  
HOWARD  
No. 12

2225  
HOWARD  
No. 12A

2226  
HOWARD  
No. 12CA

2227  
POLOKOFF  
No. 1



## Bone Chisels

### GARDNER



2228  
GARDNER  
No. 1

2229  
GARDNER  
No. 2

2230  
GARDNER  
No. 5

2231  
GARDNER  
No. 5R

### WAKEFIELD



2232  
WAKEFIELD  
No. 1W

2233  
WAKEFIELD  
No. 2W

## Bone Chisels, Bone Mallets

### Bone Chisels and Gouges

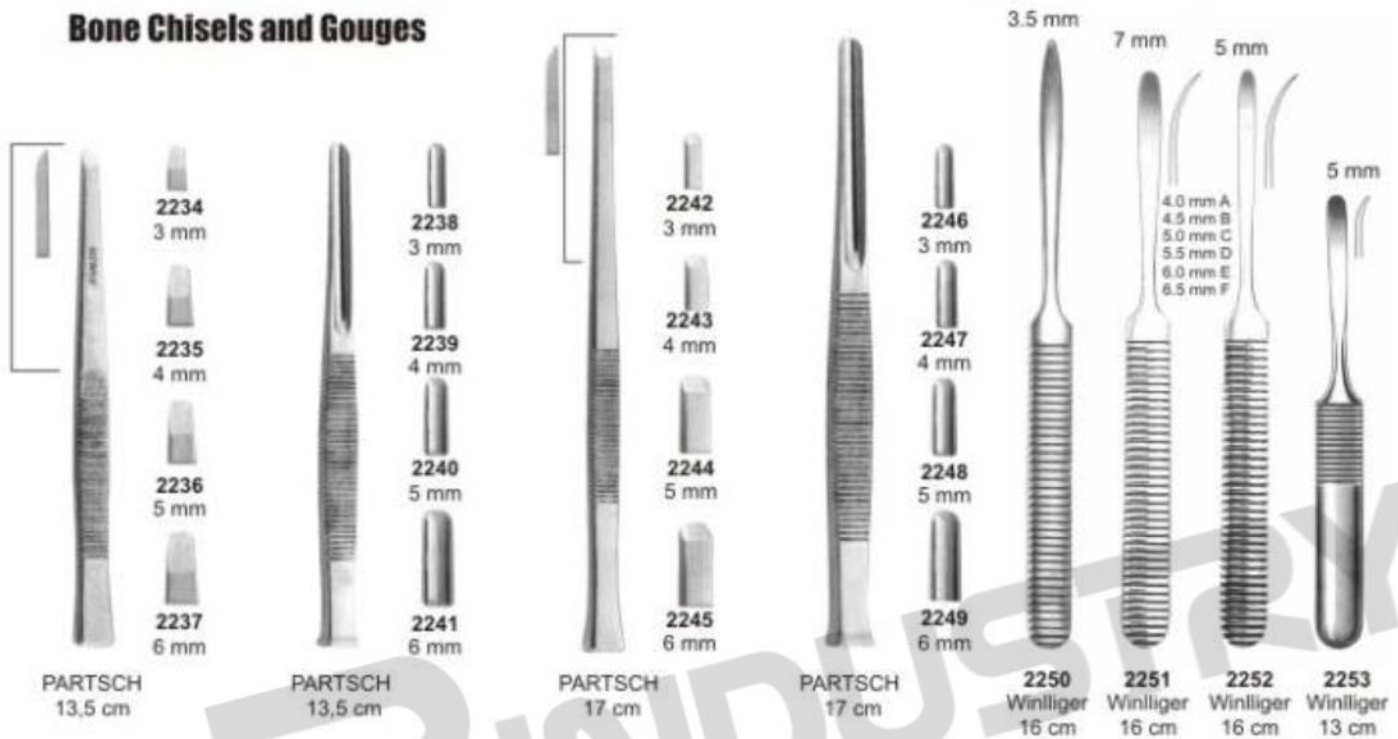

### Martelli chirurgici Mallet

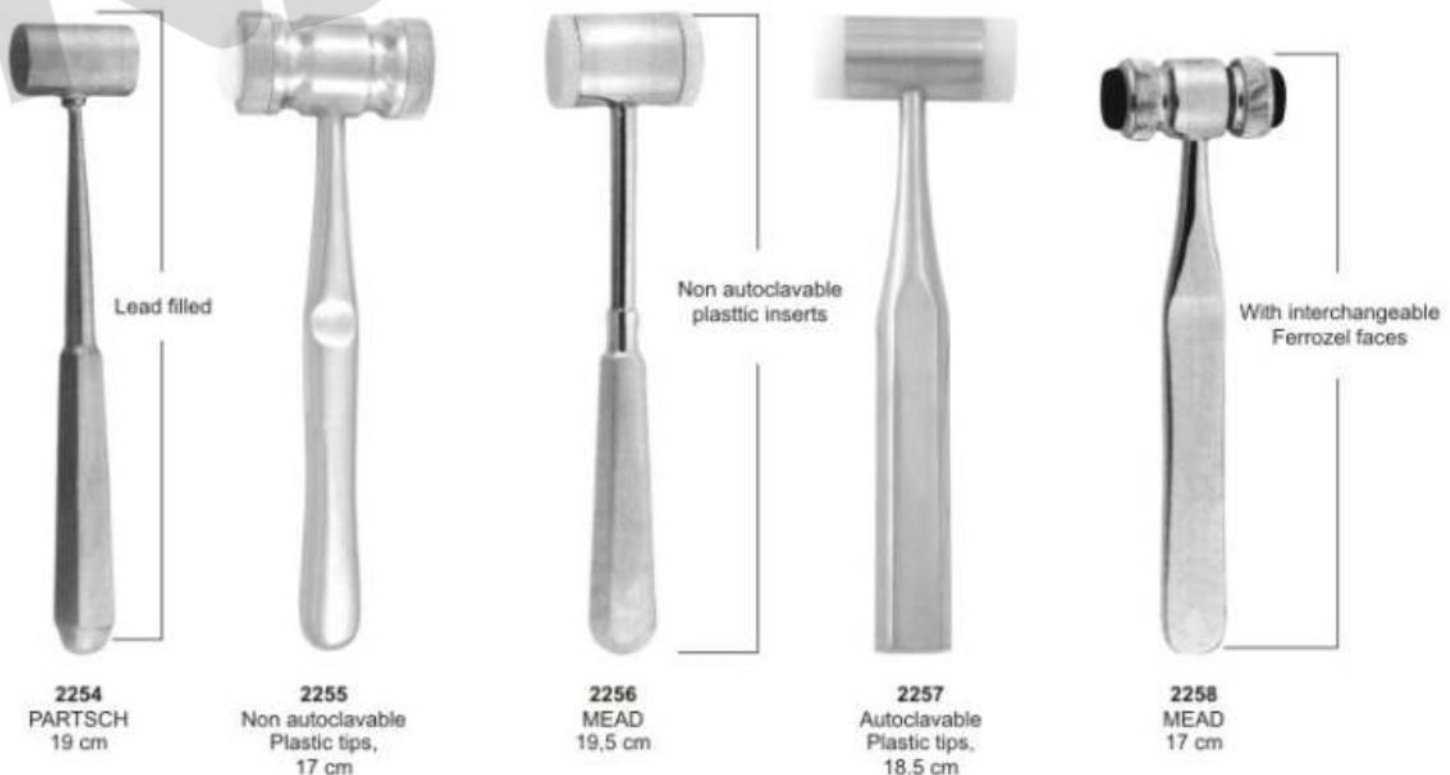

## Crown Removers

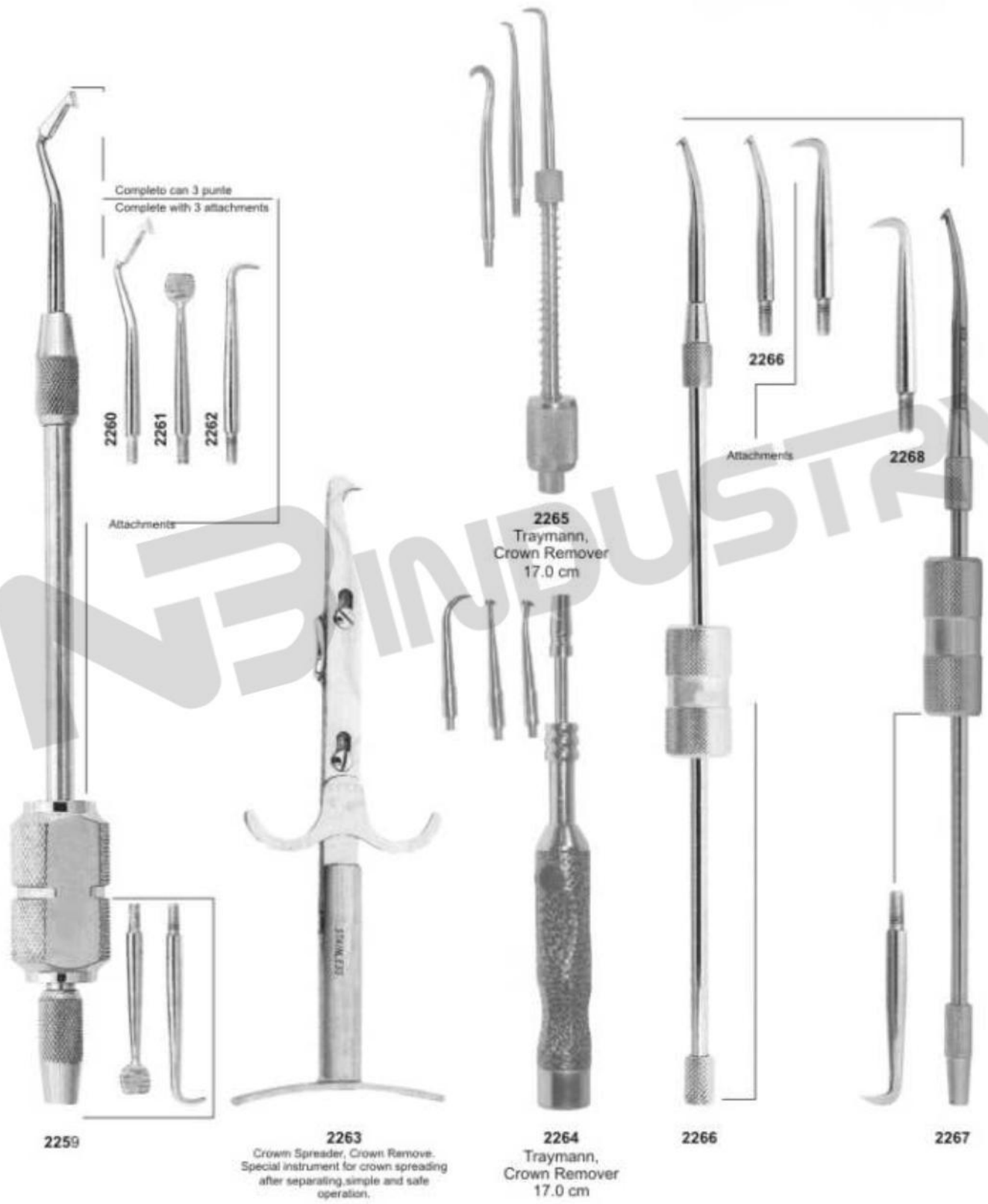

2259

**2263**  
Crown Spreader, Crown Remove.  
Special instrument for crown spreading  
after separating, simple and safe  
operation.

**2264**  
Traymann,  
Crown Remover  
17.0 cm

2266

2267

## Crown Instruments





## Crown Instruments



**2282**  
Plaster Shear  
210 mm



**2283**  
Crown Removing Plier  
14 cm



**2284**  
MONTFORT  
18 CM



**2285**  
BOHM  
16 cm



**2286**  
Telescope Crown  
Plier, Diamond coated  
13.0 cm



**2287**  
Telescope Crown  
Plier, Diamond coated  
13.0 cm



**2288**  
Telescope Crown Plier  
13.0 cm gerieften Maul  
15.0 cm gerieften Maul  
13.0 cm gelatts Maul  
15.0 cm gelatts Maul



**2289**  
Telescope Crown  
Plier, Fine  
15.0 cm

## Implants Instruments

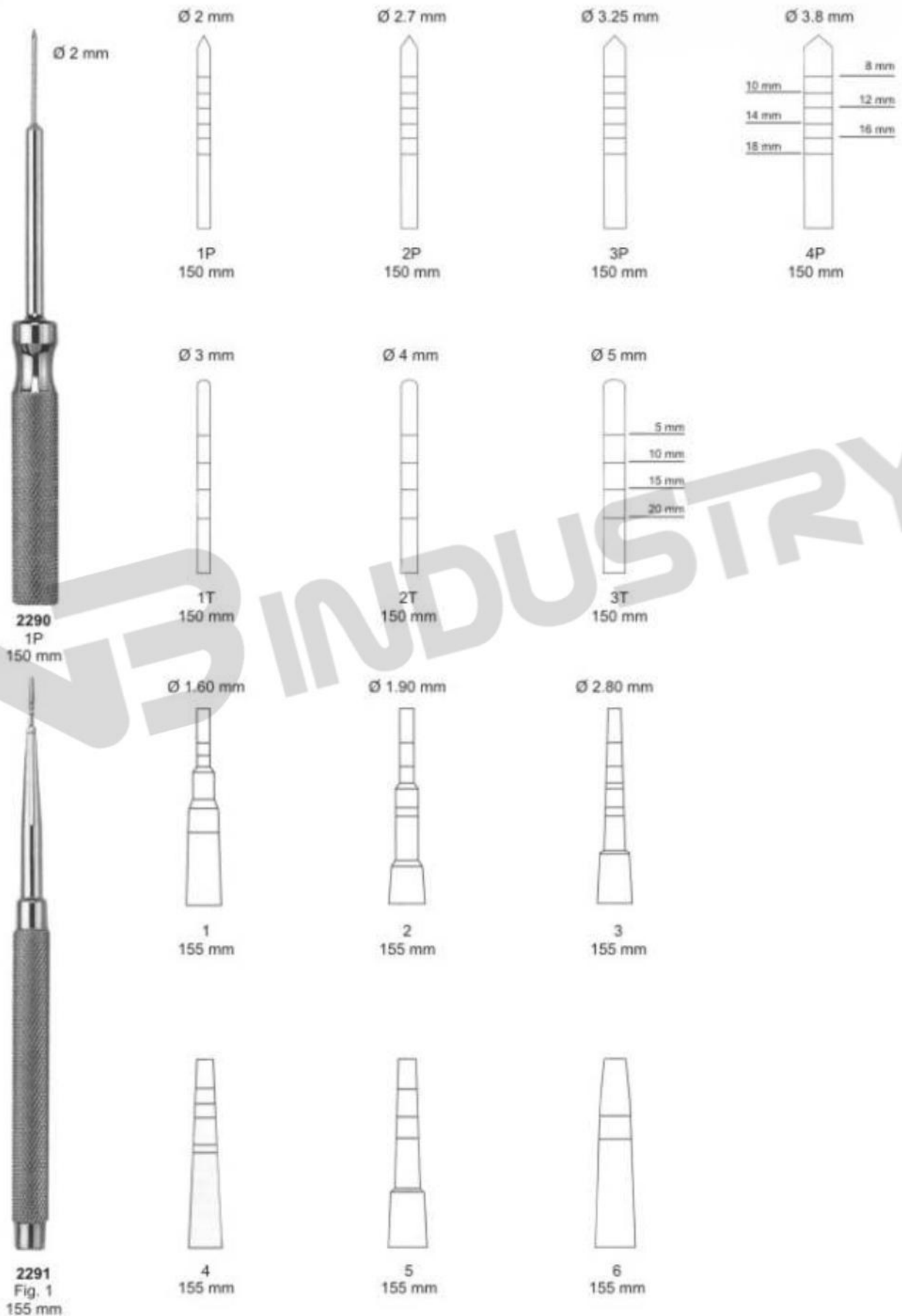

## Implants Instruments



2292  
Fig. 1B  
165 mm

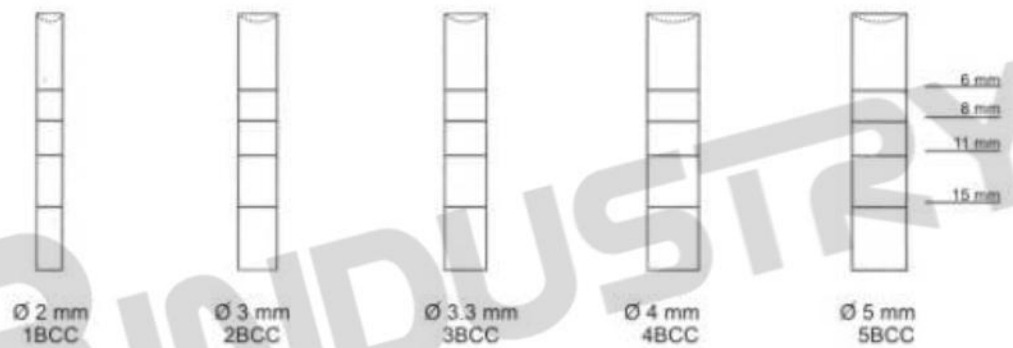
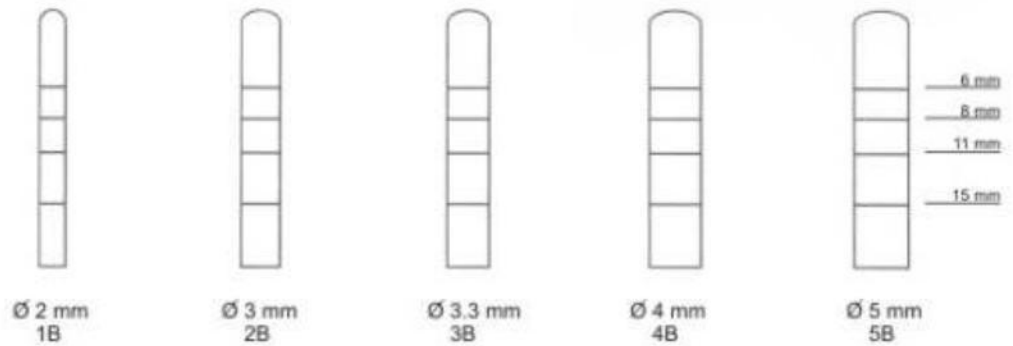

2293  
Fig. 1  
155 mm

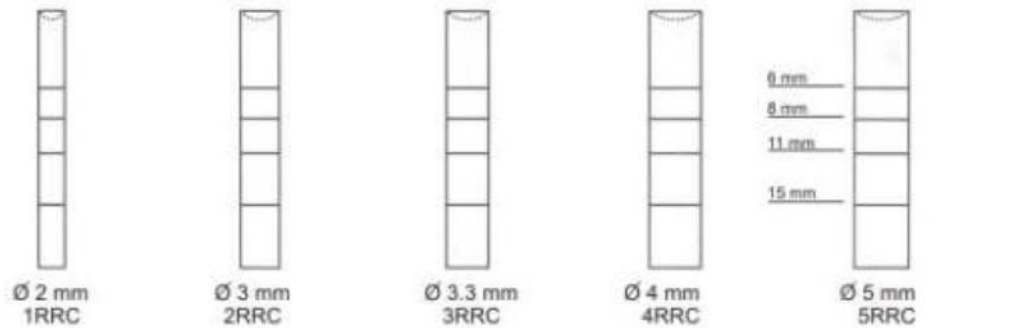
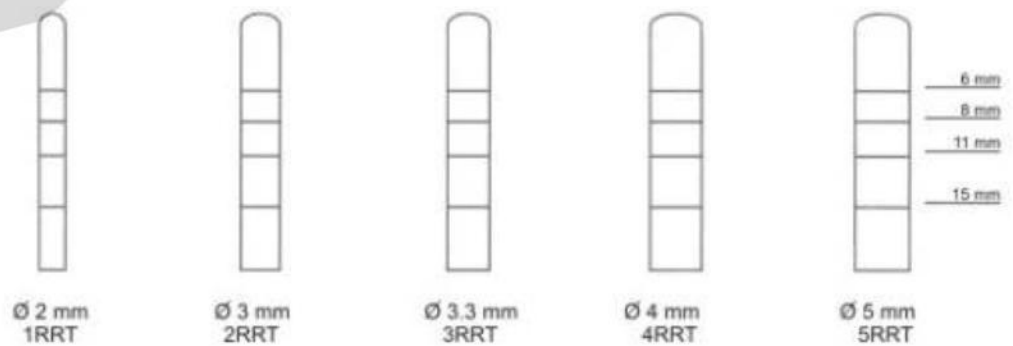

## Implants Instruments

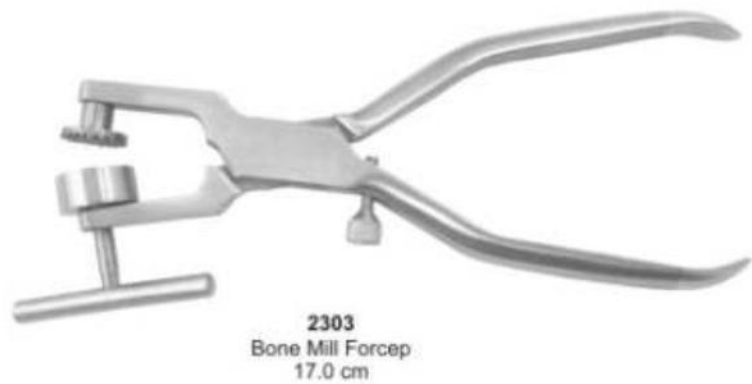
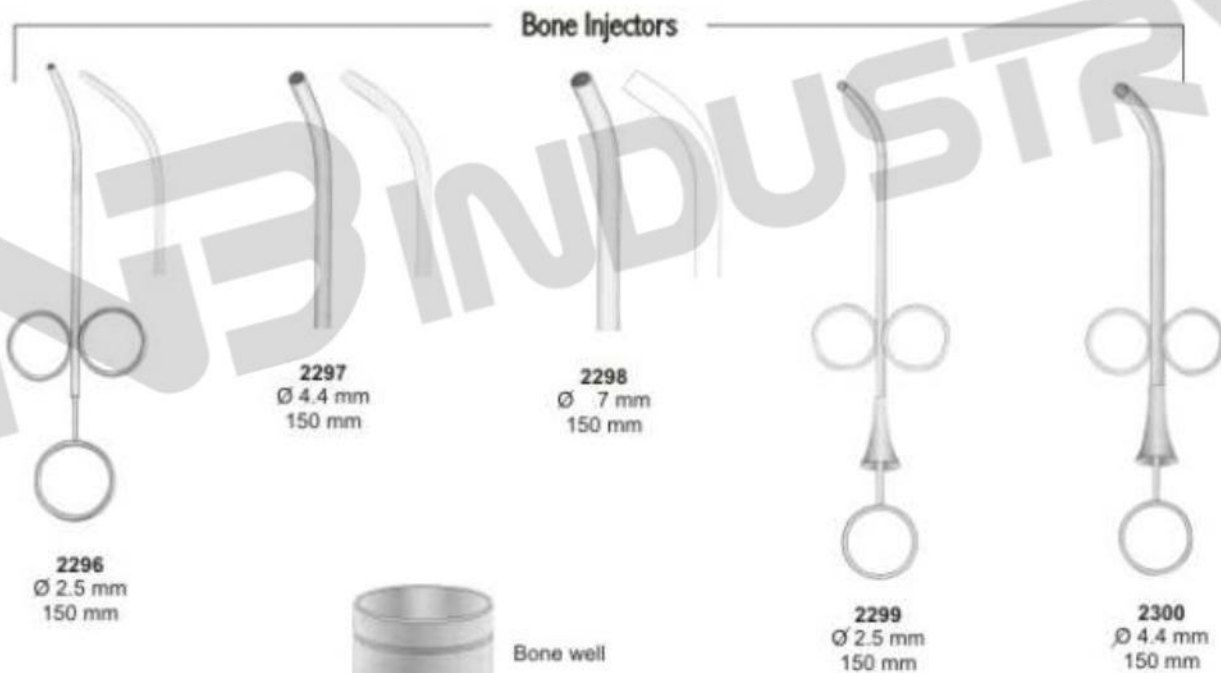
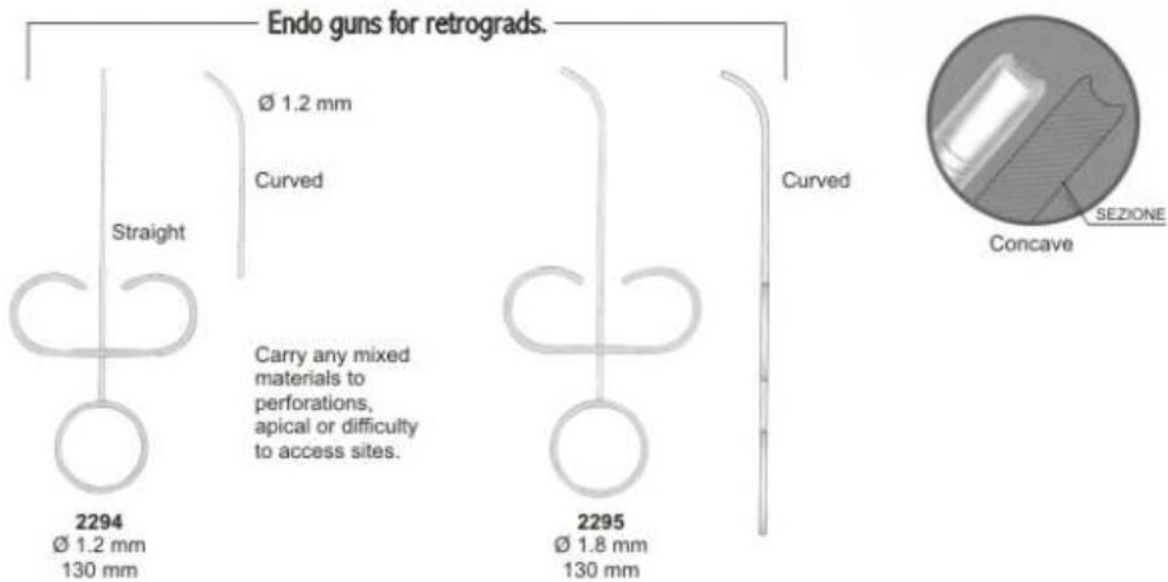



## Suction Tubes, Bone Pluggers & Rongeurs

### Suction Tubes



### Bone Pluggers



### Kerrison Rongeurs



( 1.5 mm inside ) 2311  
 ( 2.0 mm inside ) 2312  
 ( 3.0 mm inside ) 2313  
 ( 4.0 mm inside ) 2314  
 ( 4.5 mm inside ) 2315  
**16.5 cm**

( 1.0 mm inside ) 2316  
 ( 2.0 mm inside ) 2317  
 ( 2.50 mm inside ) 2318  
**16.5 cm**

## Implants Instruments



2319  
Fig. 1  
170 mm

2320  
Fig. 2  
175 mm

2321  
Fig. 3  
170 mm

2322  
LUCAS  
Fig. 88  
170 mm

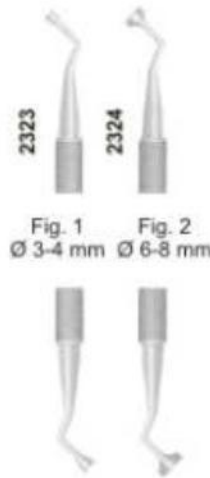

2323 Fig. 1  
Ø 3-4 mm

2324 Fig. 2  
Ø 6-8 mm

Bone Compactors.

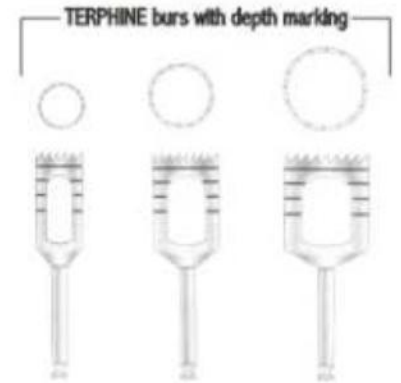

2325 Ext. Ø 3.5 mm Int. Ø 3 mm  
2326 Ext. Ø 6 mm Int. Ø 5 mm  
2327 Ext. Ø 8.5 mm Int. Ø 7.55 mm  
2328 Ext. Ø 11 mm Int. Ø 10 mm

### Sinus lift instruments



2329  
Fig.1

2330  
Fig.2

2331  
Fig.3



2332  
Fig.4

2333  
Fig.5

2334  
Fig.6

2335  
Fig.7



2336  
Fig.8

2337  
Fig.9

## Suction Tubes





## Section - 05

- \* Measuring Instruments
- \* Amalgam Guns & Carriers
- \* Retainers
- \* Rubber Dam Instruments
- \* Syringes \* Tweezers
- \* Sterilizing & Lab. Instruments





## Measuring Instruments



2348  
BOLEY Gauge



2349  
ZURICHER  
130 mm



2350  
VERNIER  
12 cm



2351  
VERNIER



2352  
VERNIER Gauge



2353  
VERNIER Gauge

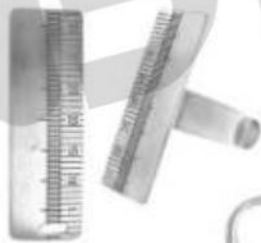

2355  
Finger Ruler



2354  
LWANSON  
Crown Gauge



2356  
LWANSON  
Crown Gauge



2357  
Sliding Gauge  
10 cm



2358  
Spring Bow Divider  
6" Radius



2359  
VERNIER  
Gauge



2360  
ALBEE



2361  
Height Gauge  
Wick Type

## Bone Gauge & Measuring Instruments



2362  
Bone Gauge



2363  
Bone Caliper  
15 cm



2364  
Castroviejo



2365 B  
Straight



2365 A  
Castroviejo  
Curved



2366 D  
Curved



2366 C  
Castroviejo  
Straight



2367  
Gauge



2368  
Castroviejo  
Straight



2370  
Castroviejo  
Straight



2373  
Boone - Gauge



2372  
Castroviejo



2374  
Curved



2375  
Straight



2376  
Bracket Gauge. Ant/Post

## Amalgam Guns & Carriers



**2377** Medium-Large 20 cm  
**2378** Medium-Jumbo 20 cm  
**2379** Large-Jumbo 20 cm  
**2380** Jumbo-Jumbo 20 cm  
**2381** Regular-Jumbo Silicon Grip 20 cm  
**2382** Medium 15.5 cm  
**2383** Large 15.5 cm  
**2384** Jumbo 15.5 cm



**2385** 145 mm  
**2386** 130 mm  
 Ø2 mm  
**2387** Straight 15 cm  
 Ø2 mm  
**2388** 15 cm  
**2389** 15 cm 90°  
**2390** Amalgam Well Non Skid Base Ø3.5 mm



## Retainers, Bands, Strip Holder Clips, Napkin Holder

### Retainers



2391  
No. 1

2392  
No. 8

2393  
No. 9

### "Tofflemire" Type Retainers



2394  
JUNIOR-CA

2395  
SENIOR-CA

2396  
UNIVERSAL

### Tofflemire Bands

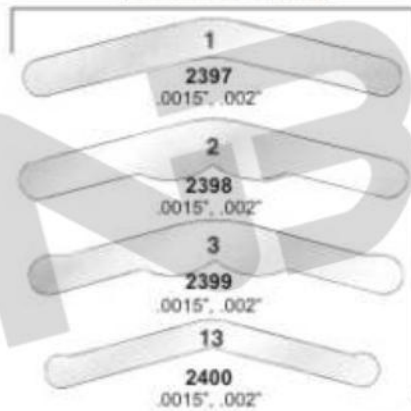

1

2397  
.0015", .002"

2

2398  
.0015", .002"

3

2399  
.0015", .002"

13

2400  
.0015", .002"

### Napkin Holders



Set of 10  
2402  
Film Hanger

2403  
BALL CHAIN

2404  
NON-CHILL  
Clear Plastic

2401  
X-Ray Holder  
Small



### Strip Holders



2408  
Strip Holder Clip  
90°

2409  
Strip Holder Clip  
45°

2405  
Finger Protector

2406  
Medium

2407  
Large



## Rubber Dam Instruments



**2410**  
IVORY  
Light weight, 170 mm



**2411**  
BREWER  
175 mm



**2412**  
BREWER  
175 mm



**2413**  
WHITE  
175 mm



**2414**  
IVORY  
170 mm



**2415**  
AINSWORTH  
Rubber Dam Punch  
170 mm



**2416**  
AINSWORTH  
Rubber Dam Punch  
170 mm



**2417**  
AINSWORTH  
Rubber Dam Punch  
170 mm



**2418**  
"IV" Type  
Rubber Dam Punch  
160 mm



**2419**  
Plastic Rubber Dam  
Frame 242

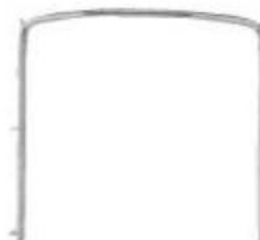

**2420**  
Rubber Dam Holder  
Stainless Steel Pins

## Articulating Paper Forceps



**2421**  
MILLER  
Articulating  
Forceps  
15 cm



**2422**  
MILLER  
Articulating  
Forceps  
15 cm

## Rubber Dam Clamps

### LOWER MOLARS



2423  
76D-W3



2424  
76D-3



2429  
76D-7A



2430  
76D-7



2435  
76D-12A



2436  
76D-13A



2441  
76D-26



2442  
76D-28



2445  
76D-W8A



2446  
76D-8A

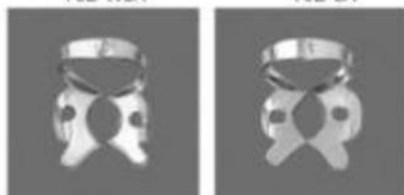

2447  
76D-10



2448  
76D-11



2451  
76D-24



2452  
76D-25

### UPPER MOLARS

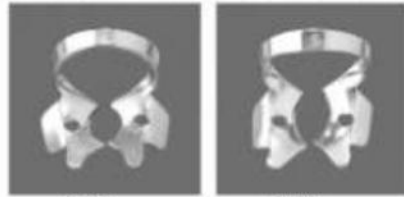

2425  
76D-4



2426  
76D-5



2431  
76D-8



2432  
76D-26N

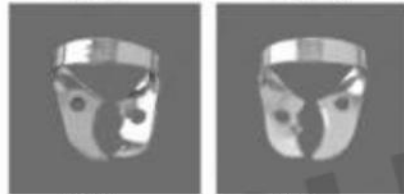

2437  
76D-30



2438  
76D-31



2443  
76D-201



2444  
205

### MOLARS



2449  
76D-14



2450  
76D-118



2453  
76D-27



2454  
76D-56



2455  
76D-14A

### PREMOLARS

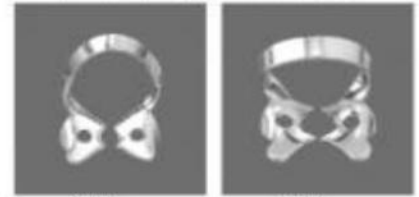

2427  
76D-0



2428  
76D-1

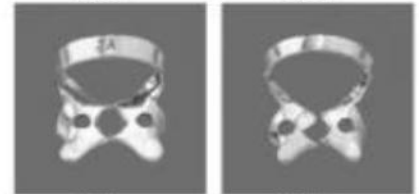

2433  
76D-2A



2434  
76D-2

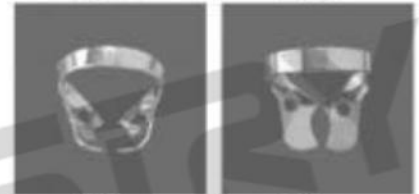

2439  
76D-27N



2440  
76D-29

### ANTERIOR

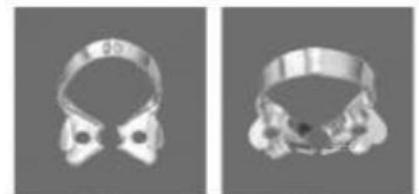

2456  
76D-00



2457  
76D-1A



2458  
76D-9



2459  
76D-212

## Aspirating Syringes

4969/CO



4969/F



4969/CV



**2460**  
ml 1,8  
EU



**2461**  
ml 1,8  
EU/AM



**2462**  
ml 1,8  
EU/AM



**2463**  
Fig. 1  
ml 1,8  
EU



**2464**  
Fig. 1  
ml 1,8  
EU



**2465**  
SS INOX  
All inox & autoclavable  
black plastic handle  
passive automatic  
aspiration.



**2466**  
Fig. 1  
ml 1,8  
EU/Am



**2467**  
Fig. 1  
ml 1,8  
EU/Am



**2468**  
Fig. 1  
ml 1,8  
EU/Am



**2469**  
ml 1,2  
EU/Am

## Syringes



**2470**  
Water Syringe  
complete with  
1 cannula (Lure-Lock)



**2471**  
Water Syringe  
complete with  
1 cannula (Lure-Lock)



**2472**  
Metal Water Syringe  
self-filling, with 1  
cannula (Lure-Lock)



**2473**  
Sparrel Barrel with  
plunger suitable for  
syringes



**2474**  
Cannula, only, with  
Luer-Lock connector  
suitable for syringes



**2475**  
Articulating  
Barrel Syringe



**2476**  
ml 1,8



**2477**  
ml 1,8



**2478**



**2479**



**2480**



**2481**  
Fig. 1  
ml 1,8 EU



**2485**  
Fig. 1  
ml 1,8 EU



**2482**  
Water  
point



**2483**  
Water  
point



**2484**  
Water  
point



## Dental Tweezers



**2486**  
ADSON  
Curved 14 cm

**2487**  
ADSON  
1X2 / 12 cm

**2488**  
ADSON  
12 cm

**2489**  
MICRO ADSON  
15 cm

**2490**  
STANDARD  
14,18,25 cm

**2491**  
CUSHING  
18 cm

**2492**  
Curved

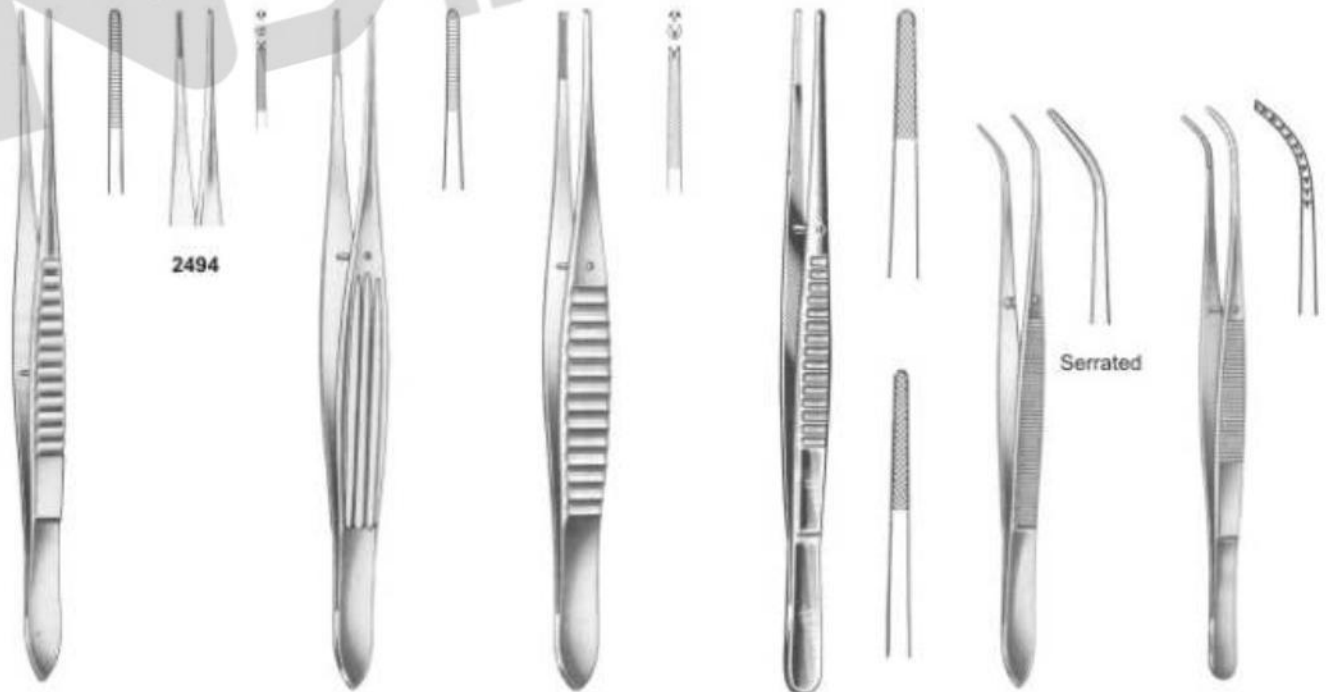

**2494**

**2493**  
SELECT  
15,18,20 cm

**2495**  
MCINDOE  
15 cm

**2496**  
GILLIES  
15 cm

**2497**  
WAUGH  
15,20 cm

**2498**  
PERRY  
13 cm

Serrated

**2499**  
KOPP  
15.5 cm

## Dental Tweezers



2500  
COLLEGE  
15 cm



smooth



2501  
COLLEGE  
15 cm



serrated



2504  
COLLEGE  
15 cm



smooth



2502  
COLLEGE  
15 cm



smooth



serrated



smooth



2505  
COLLEGE  
15 cm



serrated



2506  
COLLEGE  
15 cm



smooth



2507  
COLLEGE  
15 cm



serrated

## Dental Tweezers



2508  
MERIAM  
16 cm



smooth



2509  
MERIAM  
16 cm



serrated



2510  
MERIAM  
16 cm



smooth



2511  
MERIAM  
16 cm



serrated



2512  
MERIAM  
16 cm



smooth



2513  
MERIAM  
16 cm



serrated



2514  
MERIAM  
16 cm



smooth



2515  
MERIAM  
16 cm



serrated

## Dental Tweezers



**2516**  
COLLEGE  
14.5 cm, 5<sup>3</sup>/<sub>4</sub>"

**2517**  
FLAGG  
16 cm, 6<sup>1</sup>/<sub>4</sub>"

**2518**  
FLAGG  
16 cm, 6<sup>1</sup>/<sub>4</sub>"

**2519**  
LANDGRAF  
15 cm, 6"

**2520**  
15.5 cm, 6<sup>1</sup>/<sub>8</sub>"

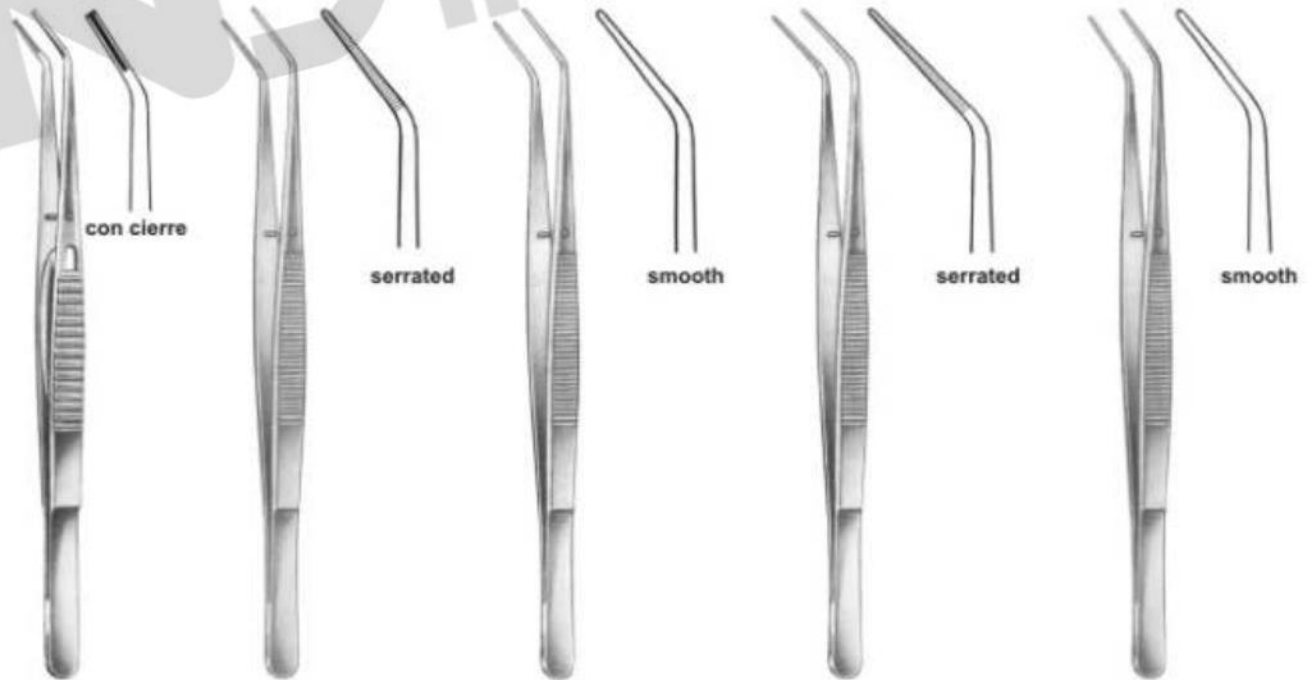

**2521**  
15.5 cm, 6<sup>1</sup>/<sub>8</sub>"

**2522**  
LONDON-COLLEGE  
15 cm, 6"

**2523**  
LONDON-COLLEGE  
15 cm, 6"

**2524**  
LONDON-COLLEGE  
15 cm, 6"

**2525**  
LONDON-COLLEGE  
15 cm, 6"



## Dental Tweezers



2526  
LONDON-COLLEGE  
15 cm, 6"



2527  
LONDON-COLLEGE  
15 cm, 6"



con cierre



2528  
MERIAM  
16 cm, 6 1/4"



serrated



smooth



2529  
ALLEN  
18 cm, 7 1/8"



2530  
ALBRECHT  
16 cm, 6 1/4"



2531  
ALBRECHT  
16 cm, 6 1/4"



2532  
16 cm, 6 1/4"



2533  
16 cm, 6 1/4"



2534  
16 cm, 6 1/4"



# N3 INDUSTRY

Manufacturer & Supplier of All kind of Surgical, Dental, Beauty Instruments.

## Sterilizing & Lab Instruments



2535  
DAVIS  
6"



2536  
Grasping Forceps  
6 1/4"



2537  
Mesh Bur & Diamond Holder  
Large, 2 1/8" Diameter



2538  
Soldering Tweezers  
6 1/4"



2539  
Narrow Fine  
4 3/4"



2540  
Super Fine  
4 3/8"



2541  
Fine Curved  
4 1/2"



2542  
Bonding Bracket  
Holder  
136 mm



2543  
Bonding Bracket  
Holder  
135 mm



2544  
Bonding Bracket  
Holder  
135 mm



2545  
Bonding Bracket  
Holder  
140 mm

## Section - 06

- \* Endodontic Forceps
- \* Tissue Forceps
- \* Retractors
- \* Mouth Gags

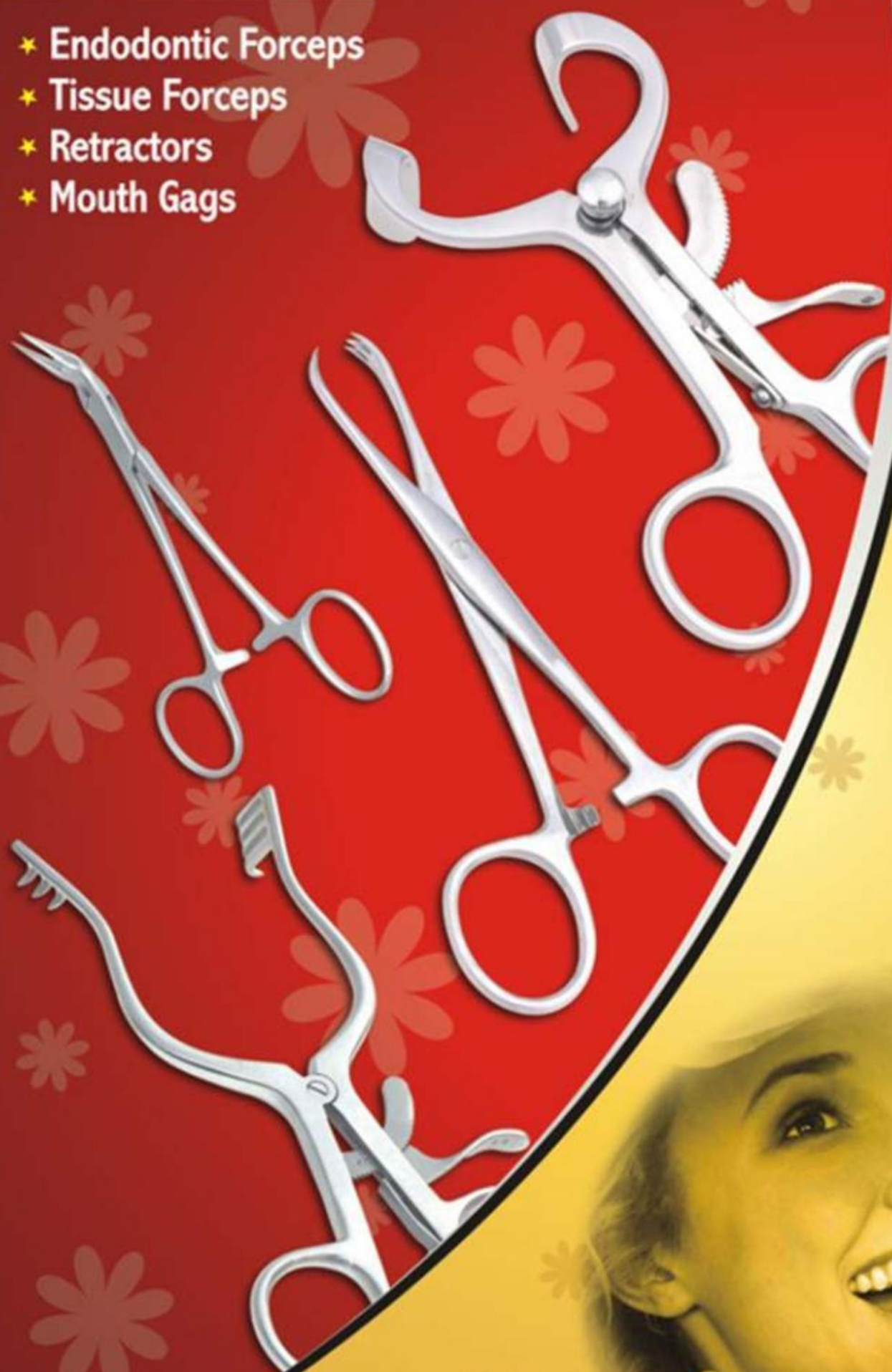



## Endodontic Forceps



**2546**  
Endo Forceps  
4 3/4"



**2547**  
PEETS Forceps  
4 3/4", Useful For  
Removing Broken  
Instruments



**2548**  
Without Ratchet  
145 mm

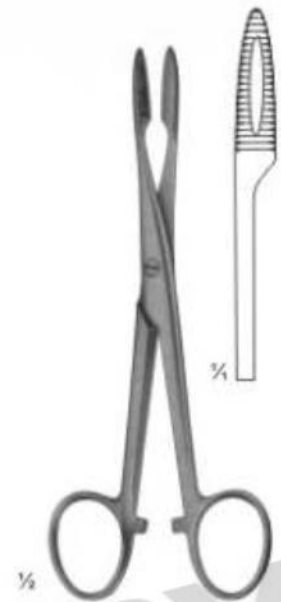

**2549**  
With Ratchet  
145 mm



**2550**  
CRILE  
140 mm

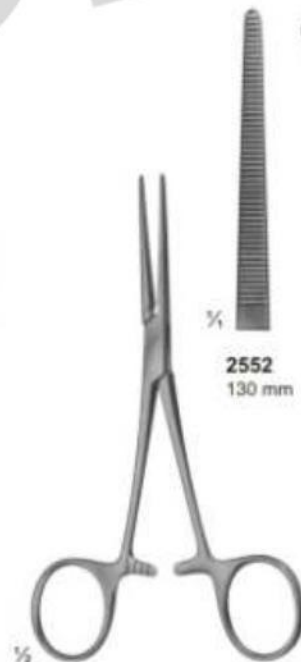

**2551**  
PEAN  
Slender type



**2554**  
SPENCER-WELLS



**2552**  
130 mm



**2553**  
140 mm



**2554**  
130 mm



**2555**  
150 mm



**2556**  
130 mm



**2557**  
150 mm



## Tissue Forceps



**2558**  
BABY-ALLIS  
5", Straight  
4x5 teeth extra delicate



**2559**  
ALLIS  
6", Straight  
4x5 teeth extra delicate



**2560**  
ALLIS  
6", Straight  
4x5 teeth extra delicate



**2561**  
1x2 teeth  
6"



**2562**  
SEMKIN  
6", Straight,  
1x2 teeth



**2563**  
ADSON  
4 3/4"  
1x2 teeth



**2564**  
BROWN-ADSON  
4 3/4"  
7x7 teeth



**2565**  
BROWN  
6"  
8x8 teeth



**2566**  
RUSSIAN  
6"  
8x8 teeth



**2567**  
Extra-Delicate,  
Straight, 4"  
1x2 teeth

## Hemostatic Forceps, Towel Clamps, Napkin Hold



**2568**  
HALSTED-MOSQUITO  
Straight, Curved, 5"



**2569**  
HALSTED-MOSQUITO  
Straight, Curved, 5"  
1x2 teeth



**2570**  
HALSTED-MOSQUITO  
Jaws 45 Angled on Flat, 5"  
Extra Delicate



**2571**  
KELLY  
5 1/2", Straight



**2572**  
JONES  
3 1/2"



**2573**  
BACKHAUS  
3 1/2"



**2574**  
BACKHAUS  
5 1/4"



**2575**  
LORNA  
Non Perforated  
3 1/2"

## Retractors, Depressors, Mouth Gags



2576  
DENHART



2577  
DENHARDT  
Mouth Gag With  
Silicon Inserts,  
Interchangeable  
Size: 125 mm



2578  
WIEDER  
Tongue depressor  
2579 140mm  
2580 150mm

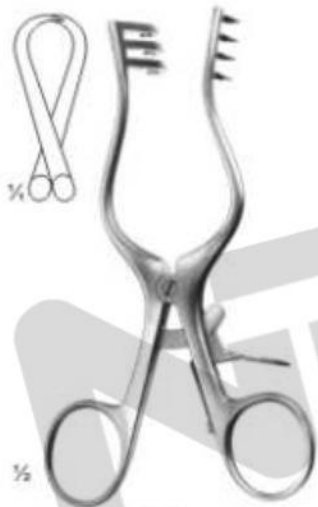

2583  
WEITLANER  
Sharp  
130 mm



2584  
WEITLANER  
Sharp  
110 mm



2585  
WEITLANER  
Semi-Sharp  
110 mm



2581  
TOBOLD  
Tongue depressor  
Size: 145 mm



2582  
ANDREW  
Tongue depressor  
Size: 110 mm



2586  
MOLT  
Pediatric



2587  
MOLT  
Child



2588  
MOLT  
Adult



2589  
FERGUSSON-ACKLAND  
Mouth Gag  
Size: 145 mm



2590  
ROSER KOENIG  
Mouth Gag  
Size: 160mm / 185mm

## Lip & Cheek Retractors



**2591**  
140 mm

**2592**  
BRUENINGS  
190 mm

**2593**

**2594**

**2595**

**2596**

**2597**

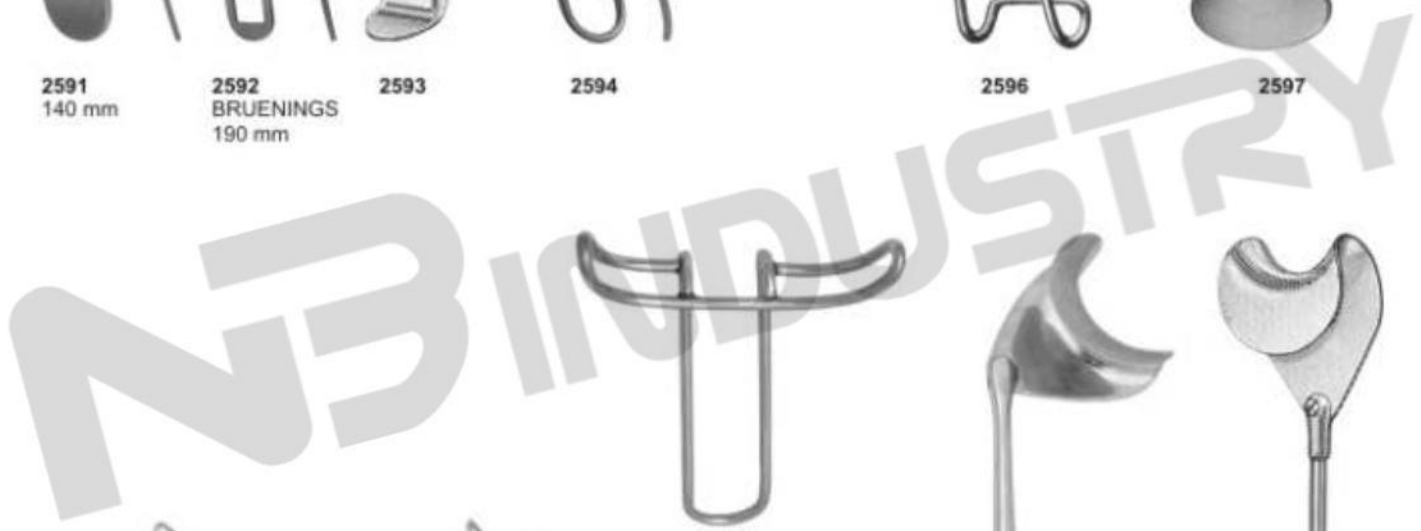

**2598**



**2602**



**2603**



**2599**  
Mouth Gag with  
Tongue Depressor  
11.0 cm  
13.0 cm  
15.0 cm



**2600**  
Mouth Gag without  
Tongue Depressor  
11.0 cm  
13.0 cm  
15.0 cm



**2601**  
Jennings, Mouth Gag  
11.0 cm  
13.0 cm  
15.0 cm



## Lip & Cheek Retractor

- 30 x 4 mm A
- 23 x 7 mm B
- 24 x 11 mm C
- 29 x 10 mm D
- 30 x 11 mm E
- 32 x 14 mm F
- 40 x 11 mm G
- 42 x 10 mm H
- 50 x 11 mm I
- 55 x 11 mm J
- 60 x 11 mm K
- 70 x 11 mm L
- 70 x 14 mm M



**2604**  
LANGENBECK  
210 mm



**2605**  
KOCHER-LANGENBECK  
215 mm



**2606**  
BUCHS  
205 mm



38 x 18 mm



**2607**  
KOCHER  
230 mm



**2608**  
MIDDELDORPF



**2609**  
15 x 15 mm  
220 mm



**2610**  
20 x 22 mm  
215 mm



**2611**  
28 x 28 mm  
235 mm



**2612**  
KOCHER  
230 mm



**2613**  
COLLIN  
150 mm



**2614**  
ROUX  
Set  
165 mm

## Sterilizing Forceps



**2615**  
Sterilizing Forcep Curved  
20 cm A  
25 cm B  
30 cm C



**2616**  
Sterilizing Forcep Straight  
20 cm A  
25 cm B  
30 cm C



**2617**  
Sterilizing Forcep  
30 cm



**2618**  
Becht Tweezer



**2619**  
Sterilizing Forcep  
23 cm A  
30 cm B



**2620**  
Sterilizing Forcep  
20 cm

## Tissue Retractors & Hooks



**2621**  
3 sharp prongs



**2622**  
2 sharp prongs  
6"



**2623**  
2 sharp prongs  
6"



**2624**  
FOMON  
145 mm



**2625**  
ALM  
70 mm



**2626**  
SENN  
3 sharp prongs  
6 3/8"



**2627**  
TOENNIS  
Dura Retractor  
150mm



**2628**  
JOSEPH  
165 mm



**2629**  
GILLIES  
180 mm



## *Section - 07*

- \* Orthodontic Pliers
- \* Orthodontic Cutters
- \* Rongeurs
- \* Needle Holders





## Orthodontic Pliers



**2630**  
Light Wire Cutter



**2631**  
Wire Cutter



**2632**  
Posterior Band Remover  
Long



**2633**  
Posterior Band Remover  
Short



**2634**  
Jarabak Plier



**2635**  
Distal End Cutter  
Safety End Cutter



**2636**  
Distal End Cutter



**2637**  
Kim's Plier



**2638**  
Loop Forming Plier



**2639**  
Tweed Arch Bending Plier



**2640**  
Utility Plier



**2641**  
Bonding Bracket Remover



**2642**  
Lingual Arch Plier



**2643**  
Light Wire Plier



**2644**  
Wire Cutter  
12.5 cm

## Orthodontic Pliers



**2645**  
Fig. 101  
Wire Bending



**2646**  
Fig. 118  
PEESO  
Collar



**2647**  
Fig. 417  
Crown Shell

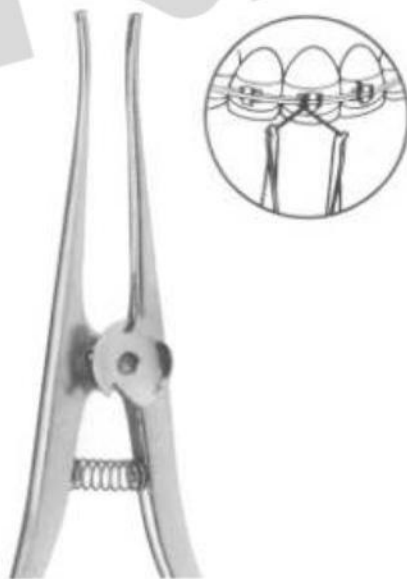

**2648**  
STEINER  
150 mm  
Ligature Pliers

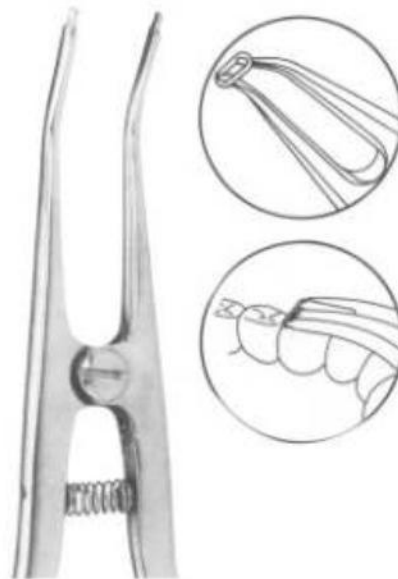

**2649**  
Separating Pliers Elastics  
150 mm



**2650**  
121-Lab & Office

## Orthodontic Pliers



**2651**  
How Plier-Titanium Alloy  
With special coated beaks

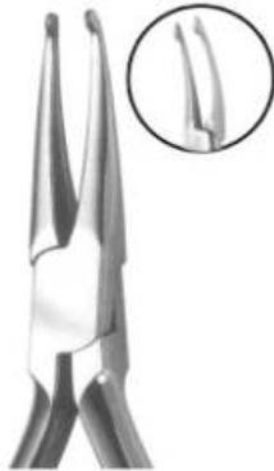

**2652**  
How Plier  
Tips are 1/8"(3.2mm)  
diameter



**2653**  
How Plier  
Tips are 1/8"(3.2mm)  
diameter



**2654**  
How Plier-Small  
Tips are 3/32"(2.4mm)  
diameter



**2655**  
How Plier-Offset  
Tips are 1/8"(3.2mm)  
diameter



**2656**  
Weingart Utility Plier  
-Titanium Alloy  
with special coated beaks

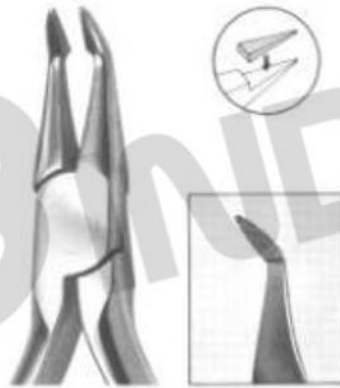

**2657**  
Weingart Utility Plier  
New type of the Weingart Utility Plier  
designed for a more precise operation.



**2658**  
Weingart Utility Plier



**2659**  
Weingart Utility Plier

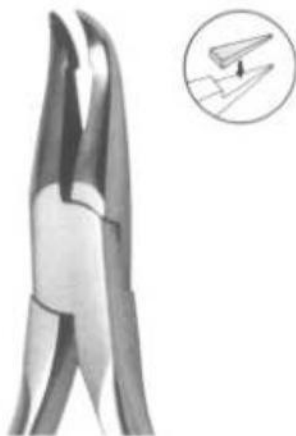

**2660**  
Weingart Utility Plier



**2661**  
Bird Beak Plier With Cutter  
Maximum Bending &  
Cutting Capacity:  
Wires up to .032"



**2662**  
Bird Beak Plier  
Maximum Bending Capacity:  
Wires up to .032"



**2663**  
Bird Beak Plier  
Maximum Bending  
Capacity:  
Wires up to .030"

## Orthodontic Pliers



**2664**  
TWEED (Fig. 98)  
13 cm, 5 1/8"  
Tweed Loop Omega Pliers.



**2665**  
TWEED - (Fig. 90)  
14 cm, 5 1/2"



**2666**  
O'BRIEN - (Fig. 97)  
14 cm, 5 1/2"

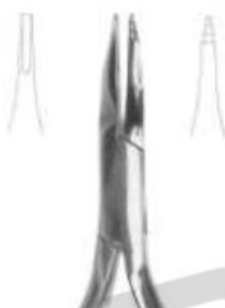

**2667**  
TWEED (Fig. 96)  
14 cm, 5 1/2"

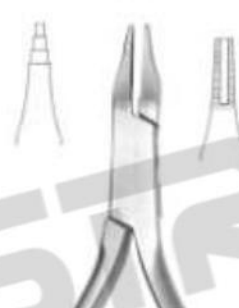

**2668**  
TWEED (Fig. 95)  
13.5 cm, 5 1/4"

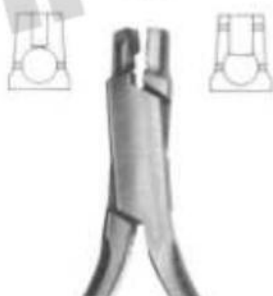

**2669**  
SCHWARZ (Fig. 29)  
12.5 cm, 5"



**2670**  
NANCE (Fig. 80)  
13 cm, 5 1/8"



**2671**  
YOUNG (Fig. 55)  
13 cm, 5 1/8"



**2672**  
SCHWARZ (Fig. 30)  
13 cm, 5 1/8"

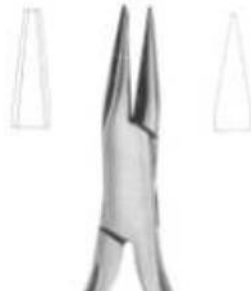

**2673**  
Optical Plier (Fig. 53)  
14 cm, 5 1/2"

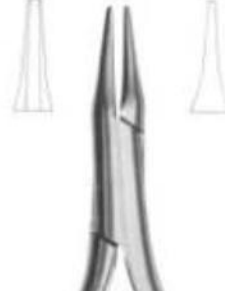

**2674**  
Schwarz (Fig. 79)  
13.5 cm, 5 1/4"



## Orthodontic Pliers



**2675**  
NANCE (Fig. 56)  
12.5 cm, 5"  
Wire bending Pliers



**2680**  
14.0 cm  
Goslee Contouring Plier



**2676**  
JOHNSON (Fig. 59)  
13.5 cm, 5 1/4"  
Contouring Plier.



**2677**  
REYNOLDS (Fig. 61)  
13 cm, 5 1/8"  
Contouring Plier.



**2678**  
De La Rosa (Fig. 34)  
12.5 cm, 5"  
Contouring Plier, Non-Grooved



**2679**  
De La Rosa (Fig. 35)  
12.5 cm, 5"  
Contouring Plier, Grooved



**2681**  
14.0 cm  
Goslee Contouring Plier



**2682**



**2683**  
Fig. 58  
12.5 cm, 5"  
Lingual Arch Bending Plier



**2684**  
Frevert/Tweed (Fig. 51)  
12.5 cm, 5"  
Tweed Arch Plier/Standard Jaw

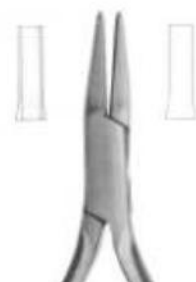

**2685**



**2686**  
ANGLE (Fig. 52)  
13 cm, 5 1/8"  
Arch Forming Plier

## Orthodontic Pliers



**2687**  
Fig. 60  
13 cm, 5 1/8"  
Wire & Clasp Bending Pliers



**2688**  
Fig. 60  
13 cm, 5 1/8"  
Wire & Clasp Bending Pliers

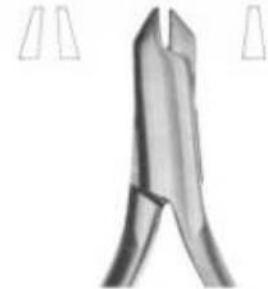

**2689**  
Aderer (Fig. 57)  
12 cm, 4 3/4"  
Wire & Clasp Bending Pliers



**2690**  
49 e 49 TC  
14 cm, 5 1/2"  
Band Removing Plier, short pad



**2691**  
50 e 50 TC  
14 cm, 5 1/2"  
Band Removing Plier, long pad



**2692**  
Fig. 84  
14.5 cm, 5 3/4"  
Band pinshing & ligature locking plier, serrated



**2693**  
Fig. 72  
14 cm, 5 1/2"  
Band pinshing & ligature locking plier, serrated



**2694**  
BRACKET (Fig. 82)  
13.5 cm, 5 1/4"  
Direct Bonding Bracket Remover



**2695**  
BRACKET (Fig. 83)  
13.5 cm, 5 1/4"  
Direct Bonding Bracket Remover

## Orthodontic Pliers



**2696**  
38c, 38TC  
13.5 cm, 5 1/4"  
Contouring closing loop pliers,  
wire bending, cutter.

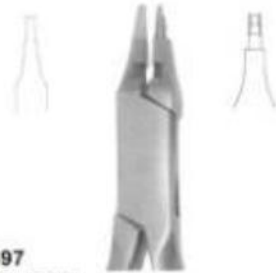

**2697**  
40c, 40TC  
13.5 cm, 5 1/4"  
Contouring pliers light wire pliers  
grooved with cutter.



**2698**  
Fig. 81  
12.5 cm, 5"  
Sling clasp & wire bending plier



**2699**  
Fig. 28  
14 cm, 5 1/2"  
Sling clasp & wire bending plier.



**2700**  
Fig. 21  
13 cm, 5 1/8"  
Light wires pliers, grooved



**2701**  
ADAMS, 23, 23TC  
12.5 cm, 5"  
Sling clasp & wire bending plier.



**2702**  
ADAMS (Fig. 33)  
12.5 cm, 5"  
For retaining elements.



**2703**  
ADAMS (Fig. 44)  
12.5 cm, 5"  
Sling clasp & wire bending plier.



**2705**  
Universal Wire Bending  
Pliers (ADAMS) 47 TC, N.64  
12.5 cm, 5"  
Sling clasp & wire bending plier.



**2706**  
86c, 86 TC  
Angle Bird Beak - N.138  
12.5 cm, 5"  
Sling clasp & wire bending plier.

## Orthodontic Cutters With T.C.



Ø 1.0 mm  
(0.40")

**2707**  
Fig. 18 TC  
15 cm, 6"



Ø 1.0 mm  
(0.40")

**2708**  
Fig. 92 TC  
14 cm, 5 1/8"



Ø 0.4 mm  
(0.16")

**2709**  
Fig. 91 TC  
13 cm, 5 1/8"



Ø 0.4 mm  
(0.16")

**2710**  
Fig. 99 TC  
13 cm, 5 1/8"



Ø 0.4 mm  
(0.16")

**2711**  
Fig. 94 TC  
13 cm, 5 1/8"  
Angled at 15° with or  
without spring on  
the handles.



**2712**  
Fig. 85 TC  
13 cm, 5 1/8"



**2713**  
Fig. 87 TC  
13 cm, 5 1/8"



**2714**  
Fig. 85 TC  
Angled at 15°  
13 cm, 5 1/8"



**2715**  
ADAMS 87 TC  
Angled at 15°  
13 cm, 5 1/8"



## Orthodontic Distal & Cutters



## Pliers for Orthodontic & Prosthetics



2721  
UNIVERSAL  
150 mm



2722  
WALDSACHS  
155 mm



2723  
ADERER  
125 mm



2724  
NANCE  
125 mm



2725  
REYNOLDS  
125 mm



2726  
HOW  
145 mm



2727  
HOW  
140 mm



2728  
WALDRON  
125 mm



2729  
ADAMS  
125 mm



2730  
ANGLE  
125 mm



2731  
FURRER  
150 mm

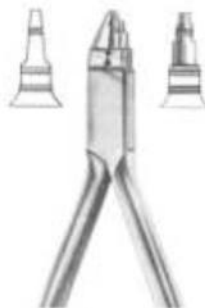

2732  
YOUNG  
130 mm



2733  
NANCE  
130 mm

## Pliers for Orthodontic & Prosthetics



**2734**  
LANGEBECK  
125 mm



**2735**  
LANGEBECK  
140 mm



**2736**  
LANGEBECK  
130 mm



**2737**  
PEESO  
125 mm



**2738**  
GOSLEE  
125 mm



**2739**  
FISCHER  
140 mm



**2740**  
FISCHER  
140 mm



**2741**  
JOHNSON  
130 mm



**2742**  
MSY  
130 mm



**2743**  
MC KELLOPS  
155 mm



**2744**  
ANDRESEN  
130 mm



**2745**  
SCHWARZ  
130 mm

## Rongeurs



2746  
BLUMENTHAL  
6", 30°, Standard



2747  
MINI-BLUMENTHAL  
6", 45°



2748  
MINI-BLUMENTHAL  
6", 90°

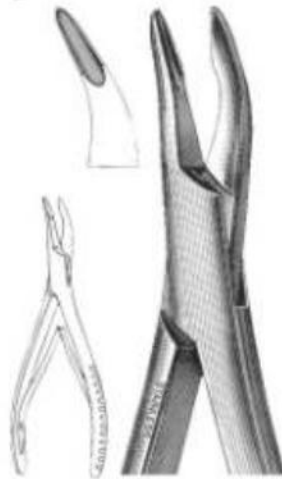

2749  
BLUMENTHAL  
7", 30°

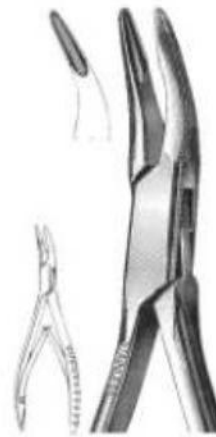

2750  
MINI-BLUMENTHAL  
4 1/2", 30°

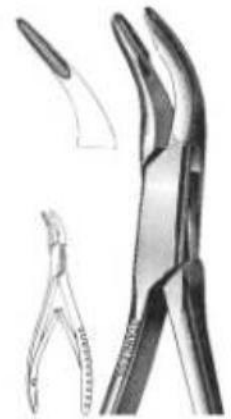

2751  
MINI-BLUMENTHAL  
4 1/2", 45°



## Rongeurs



**2752**  
CLEVELAND  
No. 5-Side Cutting,  
6 3/4"

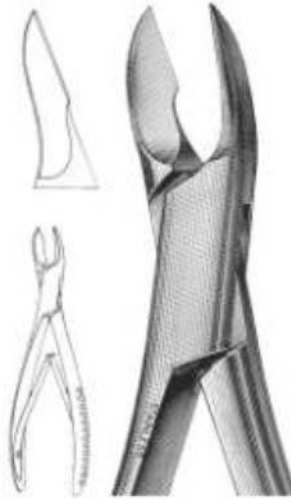

**2753**  
CLEVELAND  
No. 5A-Side Cutting,  
6 1/2"

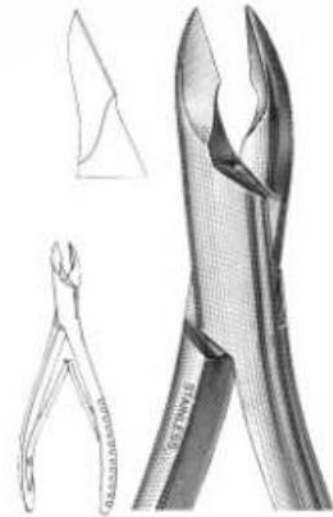

**2754**  
CLEVELAND  
No. 5S-Side Cutting,  
6"



**2755**  
No. 1A-MEAD  
6 1/2"



**2756**  
MEAD, Square  
No. 2A  
Tips, 6 1/2"



**2757**

## Rongeurs

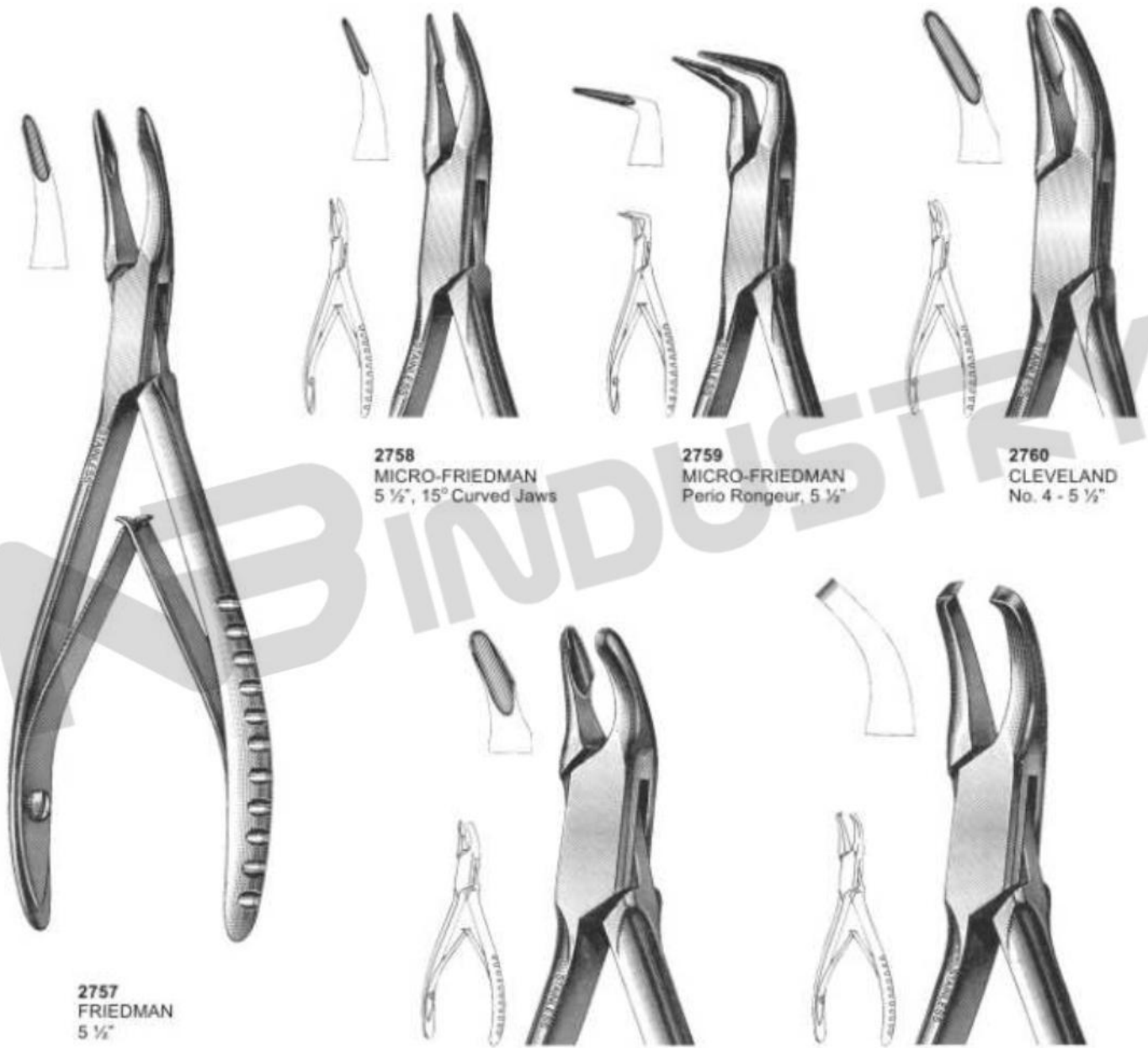

**2758**  
MICRO-FRIEDMAN  
5 1/2", 15° Curved Jaws

**2759**  
MICRO-FRIEDMAN  
Perio Rongeur, 5 1/2"

**2760**  
CLEVELAND  
No. 4 - 5 1/2"

**2757**  
FRIEDMAN  
5 1/2"

**2761**  
CLEVELAND  
No. 4A - 6 1/2"

**2762**  
GARDNER  
No. 6A, End Cutting  
6 1/2"

## Rongeurs



**2763**  
BEYER  
Double Action,  
16, 18 cm



**2764**  
No. 1  
6 1/2"

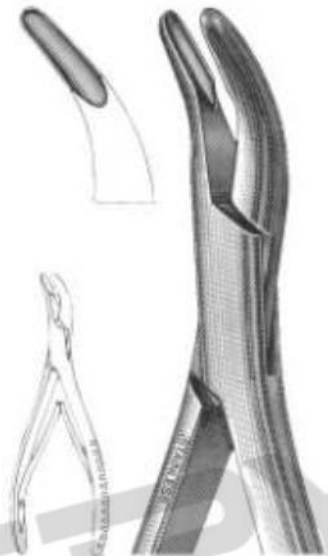

**2765**  
HARTMAN  
5 3/4"  
Strong Curve

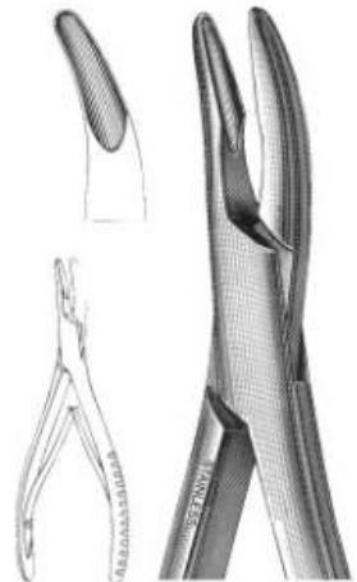

**2766**  
BANE  
Slight Curve  
7"

## Needle Holders



**2767**  
COLLIER  
5", Fenestrated Jaws



**2768**  
DERF  
4 3/4"



**2769**  
WEBSTER  
Delicate Smooth Jaws  
5"



**2770**  
NEIVERT  
One Offset Ring  
5"



**2771**  
OLSEN-HEGAR  
5 1/2"



**2772**  
BAUMGARTNER  
5 1/2"



**2773**  
CRILE-WOOD  
6"



**2774**  
GARDNER  
5"



## Needle Holders



## Micro Surgery Set



**2785**  
Micro Scissor  
Straight, 155 mm



**2786**  
Micro Scissor  
Straight, 150 mm



**2787**  
Micro Scissor  
Curved, 150 mm



**2788**  
Micro Scissor  
Curved, 155 mm



**2789**  
CASTROVIEJO  
T.C.  
Straight, 180 mm



**2790**  
Retractor  
Fig.3  
165 mm



**2791**  
Micro Adson  
120 mm



**2792**  
GERALD  
Curved,  
180 mm



**2793**  
GERALD  
Straight,  
175 mm



**2794**  
Micro Adson  
160 mm



**2795**  
Micro Surgery Set 10 Pieces.



## Section - 08

- ★ Scissors
- ★ Impression Trays
- ★ Articulators
- ★ Hollow Wares
- ★ T.C. Instruments



## Scissors



**2796**  
IRIS (Standard)  
Straight  
11.5 cm, 4 1/8"



**2797**  
IRIS (Standard)  
Curved  
11.5 cm, 4 1/8"



**2798**  
STEVENS  
Dissecting Scissors  
Size: 115 mm



**2799**  
Sharp



**2800**  
Sharp



**2801**  
Blunt



**2802**  
Blunt



**2803**



**2804**  
JOSEPH  
Size: 150 mm

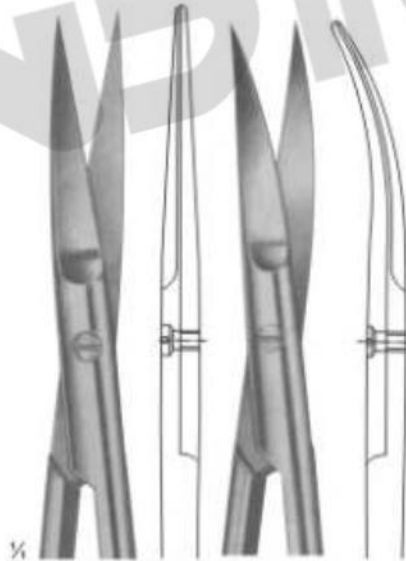

**2805**



**2806**

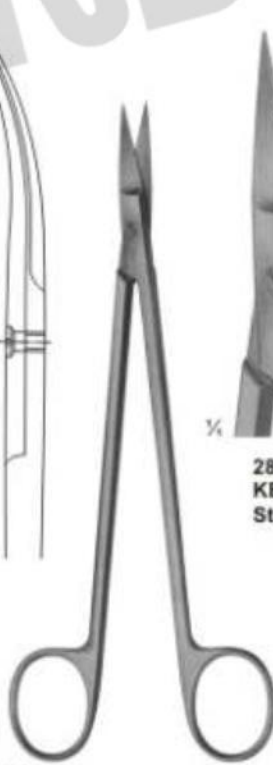

**2807**  
KELLY  
Size: 175 mm



**2808**  
KELLY  
Straight

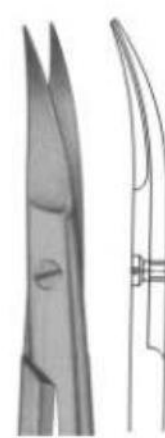

**2809**  
KELLY  
Curved

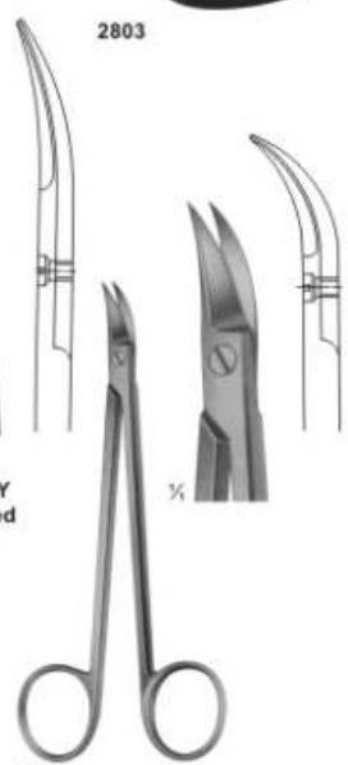

**2810**  
QUINBY  
Size: 130 mm



## Scissors

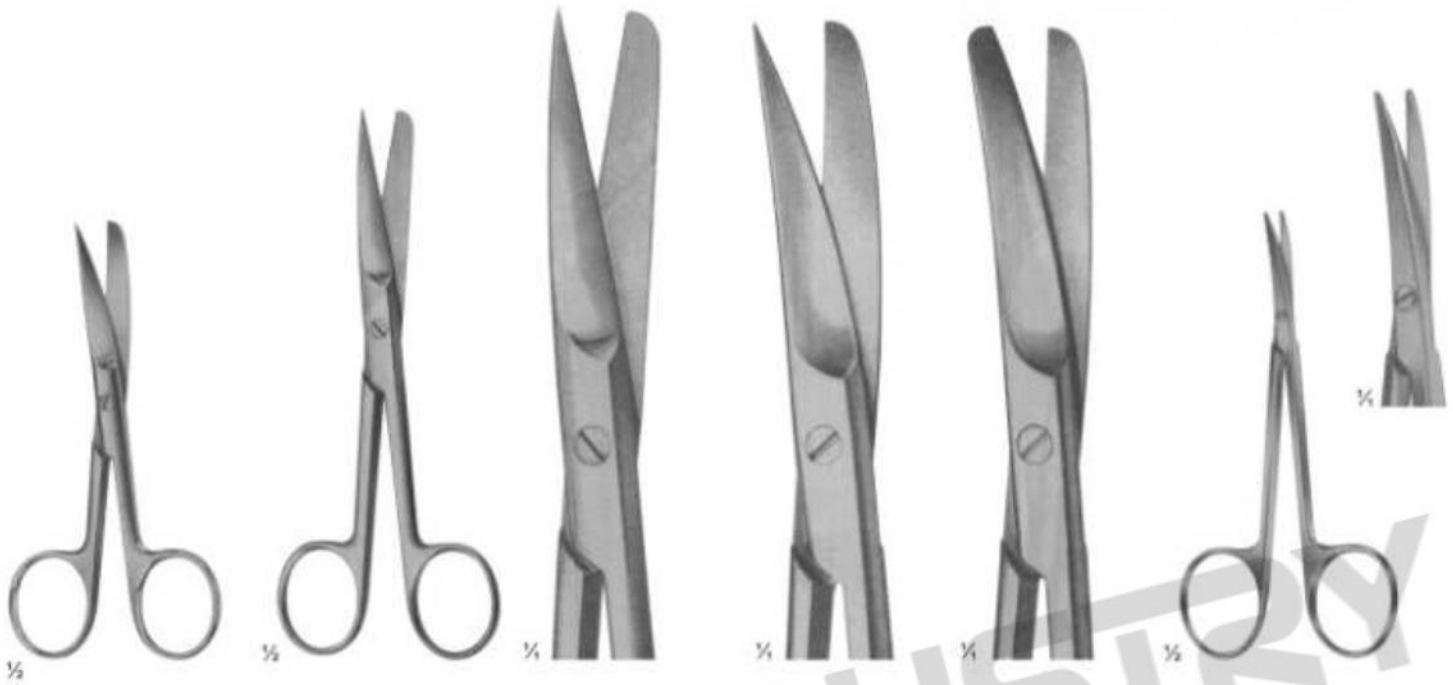

**2811**  
Standard - Types  
Size: 115 mm

**2812**  
DEAVER  
With flat lock

**2813**  
Size: 145 mm

**2814**  
Size: 145 mm

**2815**  
Size: 145 mm

**2816**  
LITTLER  
Dissecting Scissors  
Size: 115 mm

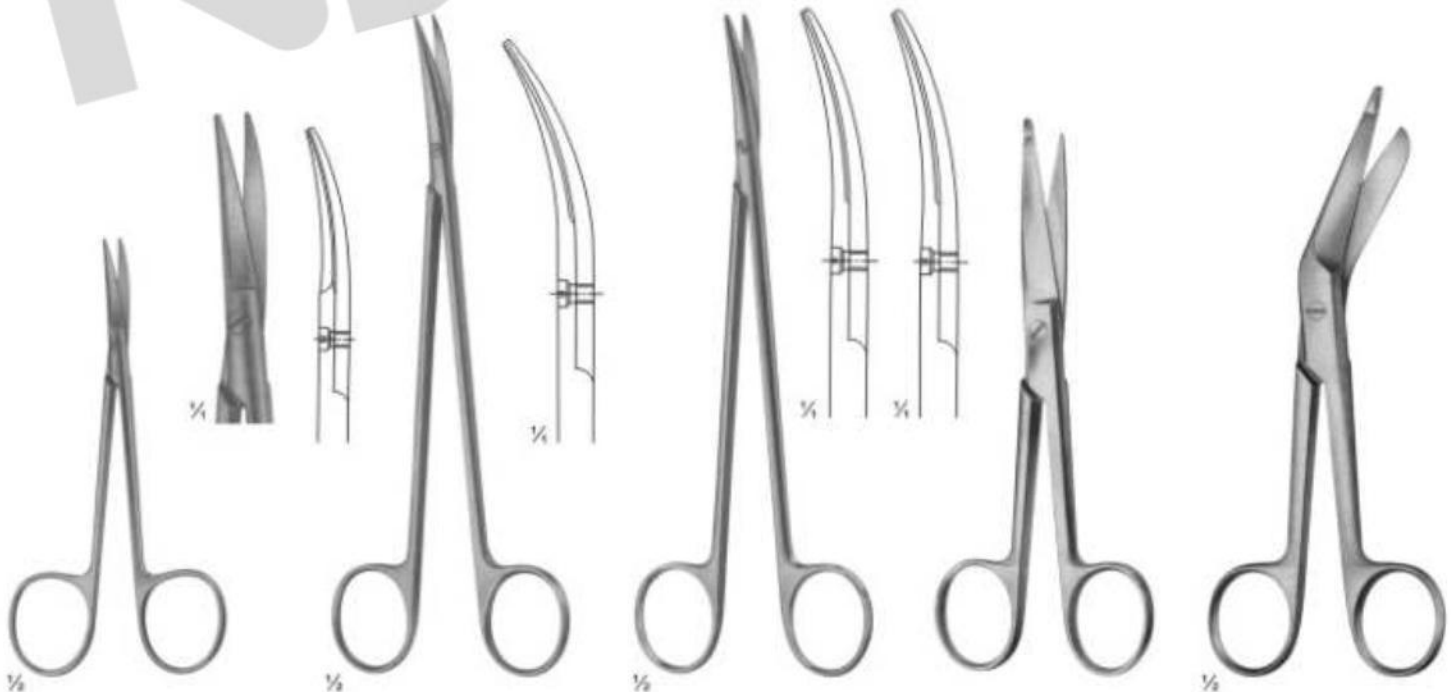

**2817**  
COTTLE  
Bulldog Scissors  
Size: 115 mm

**2818**  
DE BAKEY  
Ateriotomy scissors  
Size: 175 mm

**2819**  
TOENNIS - ADSON  
Dissecting scissors  
Size: 175 mm

**2820**  
KNOWLES  
Size: 145 mm

**2821**  
LISTER

## Scissors

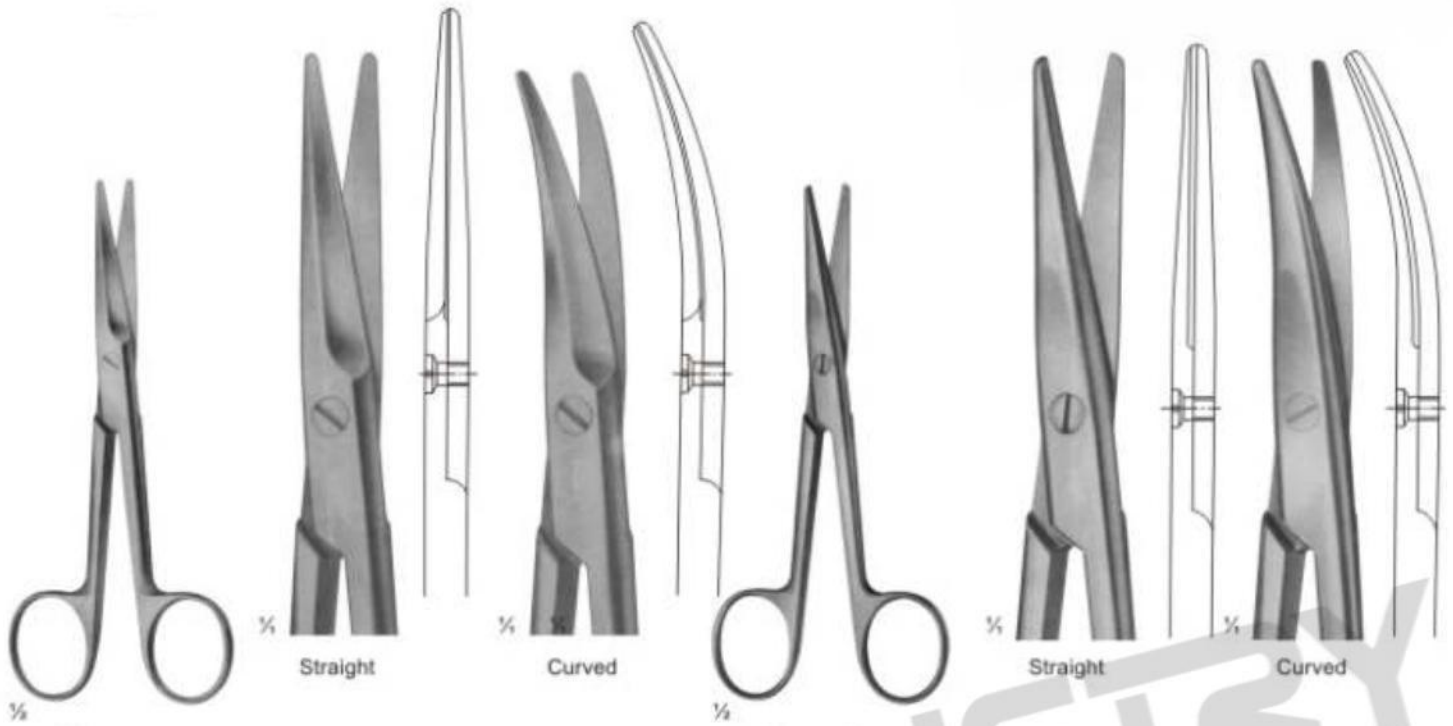

2822  
MAYO(straight)  
Size: 140 mm

2823  
MAYO-STILLE (straight)  
Size: 140 mm



2824  
STILLE

2825  
METZENBAUM

2826  
NELSON-METZENBAUM

## Scissors





## Impression Trays

Made of 18/8 Stainless Steel, Solid, Set of 10

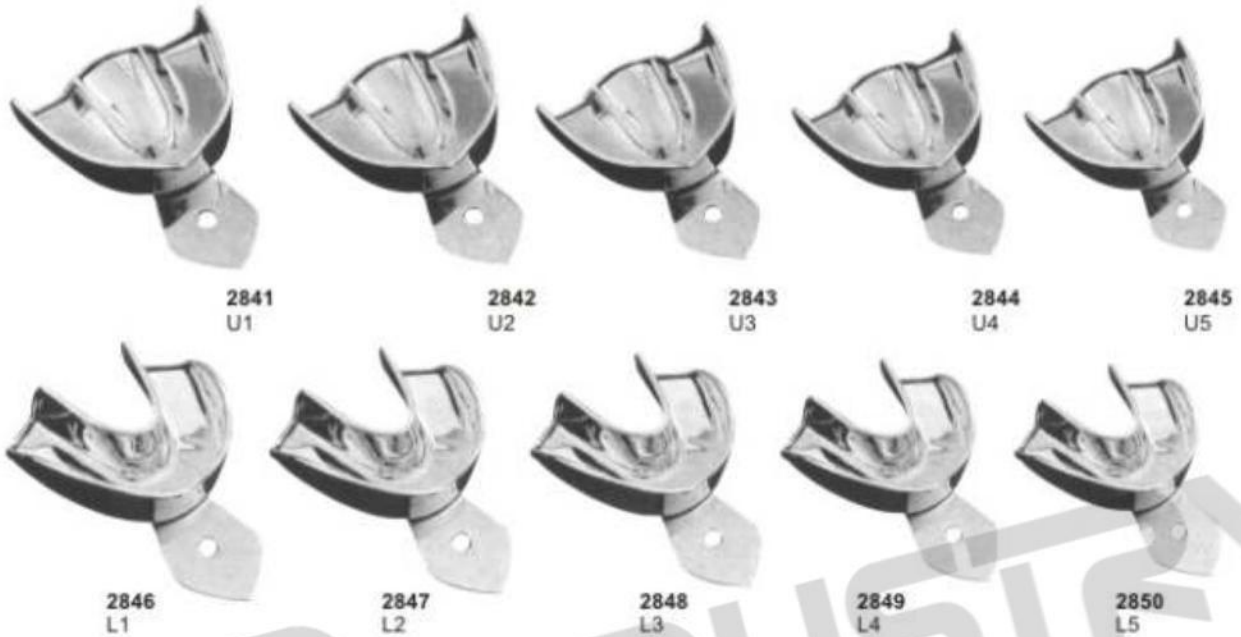

All The Above Impression Trays are Available in These 5 Sizes

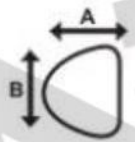

UPPER		U1	U2	U3	U4	U5
	A	62	60	53	54	52
B	83	75	73	69	68	

All Dimension are in mm

LOWER		L1	L2	L3	L4	L5
	A	63	61	57	60	53
B	82	81	78	74	71	

All Dimension are in mm

Perforated, Set of 10

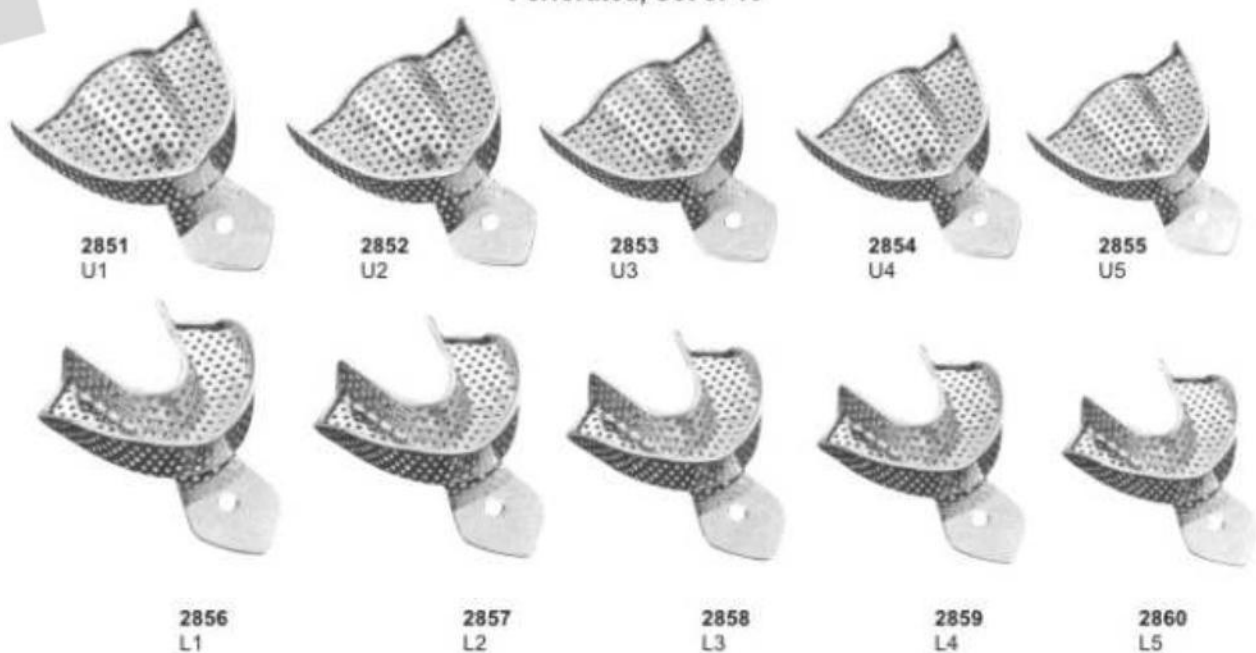



## Impression Trays

Made of 18/8 Stainless Steel, Solid Full Denture Set of 8

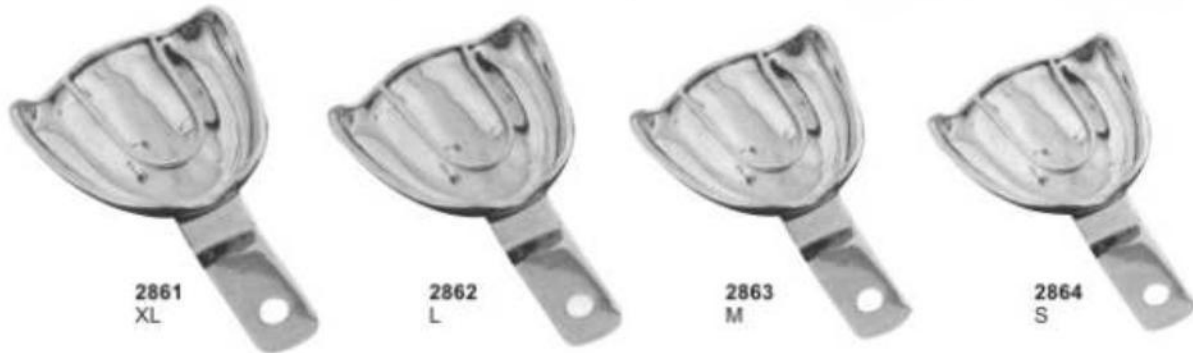

All The Above Impression Trays are Available in These 4 Sizes

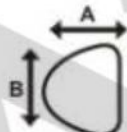

UPPER		XL	L	M	S
	A	70	67	64	60
B	79	76	70	73	

All Dimension are in mm

LOWER		XL	L	M	S
	A	64	64	60	57
B	86	70	73	70	

All Dimension are in mm

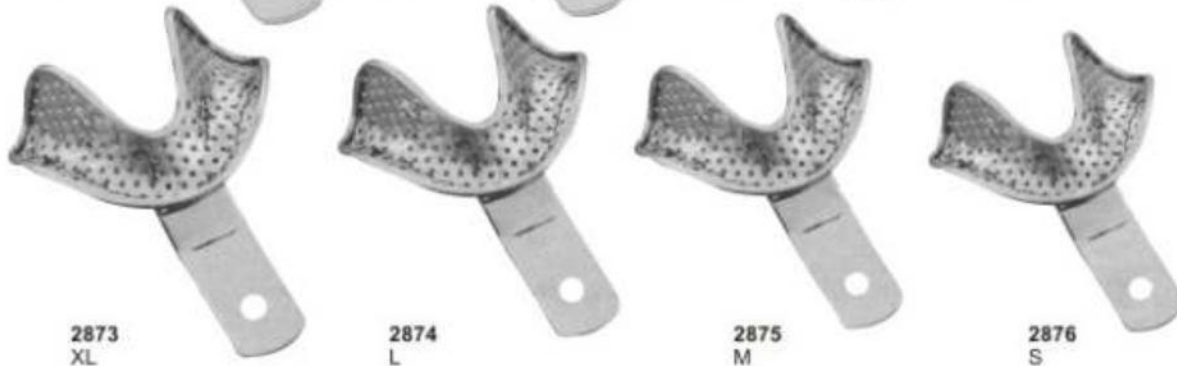
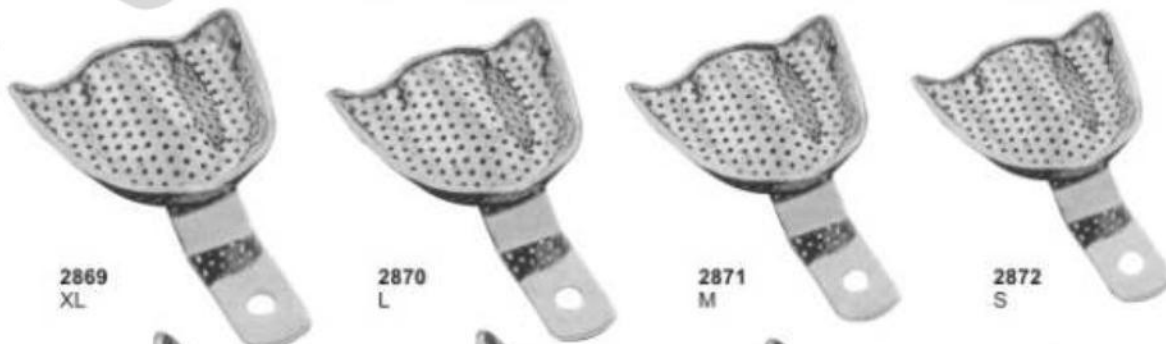

Perforated Full Denture Set of 8

## Impression Trays

Made of 18/8 Stainless Steel, Solid Set of 6



2877  
U1



2878  
U2



2879  
U3

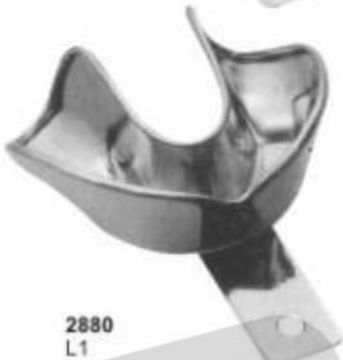

2880  
L1



2881  
L2



2882  
L3

All The Above Impression Trays are Available in These 4 Sizes

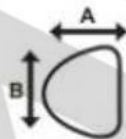

UPPER		U1	U2	U3
	A	67	64	57
B	81	71	70	

All Dimension are in mm

LOWER		L1	L2	L3
	A	60	57	54
B	81	79	76	

All Dimension are in mm

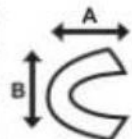

2883  
U1



2884  
7U2



2885  
U3



2886  
L1



2887  
L2



2888  
L3

Perforated Set of 6

## Impression Trays

Made of 18/8 Stainless Steel, English Pattern Set of 8



2889  
Lower



2890  
Upper



2891  
Lower



2892  
Upper



2893  
Lower



2894  
Upper

All The Above Impression Trays are Available in These 4 Sizes

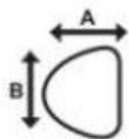

UPPER	Size	A	B	C
	0	67	50	12
	1	72	51	13
	2	78	55	15
	3	80	58	15

All Dimension are in mm

LOWER	Size	A	B	C
	0	70	50	14
	1	77	51	15
	2	79	55	15
	3	80	60	17

All Dimension are in mm

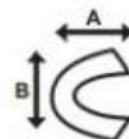



## Impression Trays

Made of 18/8 Stainless Steel, Solid Full Denture Set of 8

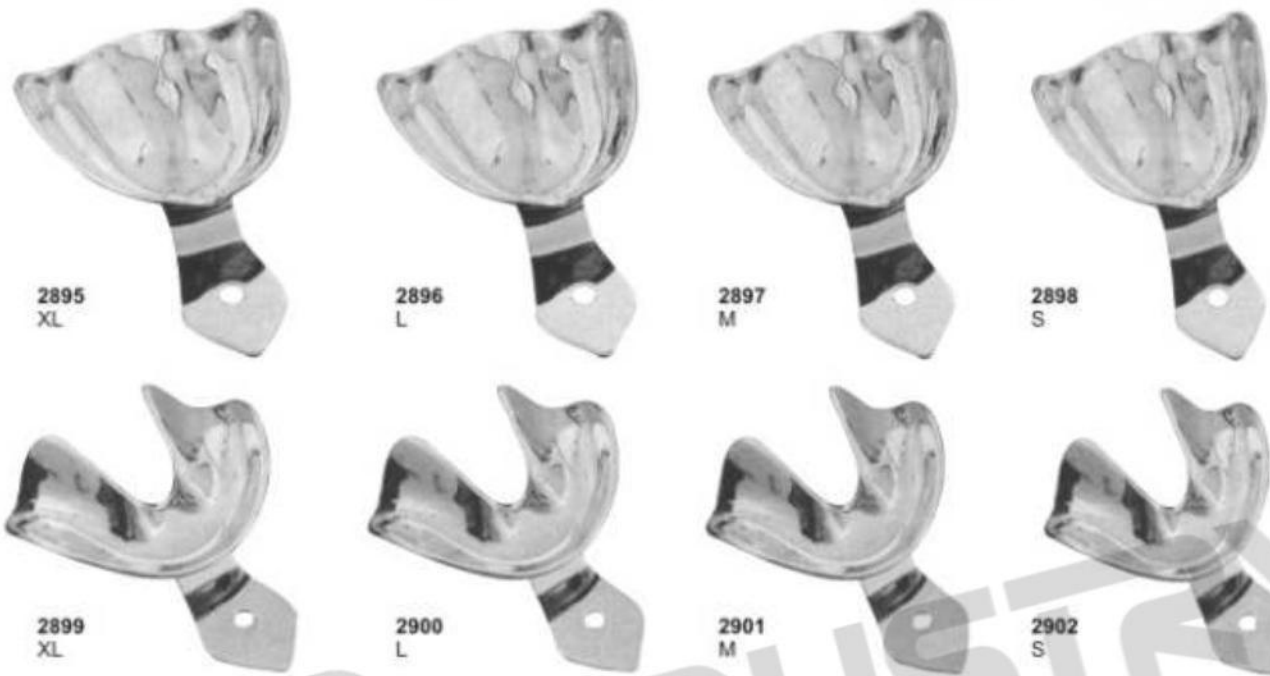

2895  
XL

2896  
L

2897  
M

2898  
S

2899  
XL

2900  
L

2901  
M

2902  
S

All The Above Impression Trays are Available in These 4 Sizes



UPPER		XL	L	M	S
	A	70	67	64	60
B	79	76	70	73	

All Dimension are in mm

LOWER		XL	L	M	S
	A	64	64	60	57
B	86	70	73	70	

All Dimension are in mm

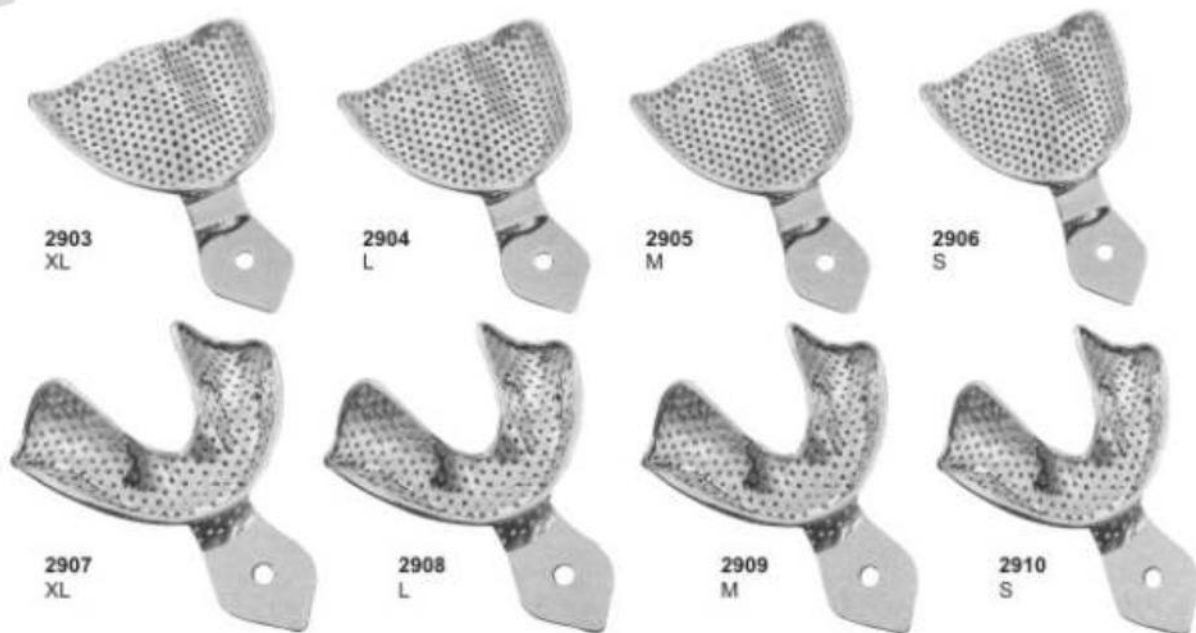

2903  
XL

2904  
L

2905  
M

2906  
S

2907  
XL

2908  
L

2909  
M

2910  
S

Made of 18/8 Stainless Steel, Perforated Full Denture Set of 8



## Impression Trays

Made of 18/8 Stainless Steel, Solid Full Denture Set of 8

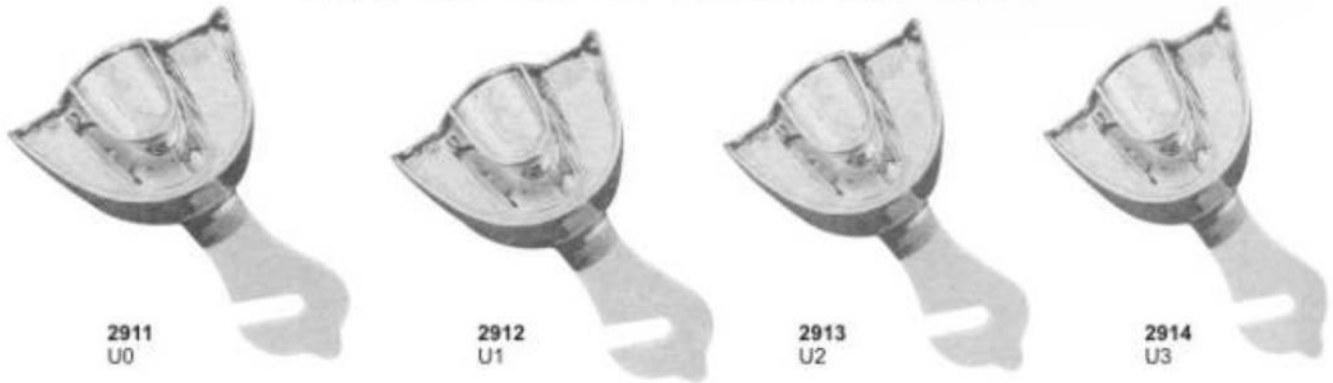

Upper Sizes: 0,1,2,3

Depth of Tray: 15,9 mm, Height of Plate: 12,5 mm

Lower Sizes: 0,1,2,3

Depth of Tray: 12,9 mm

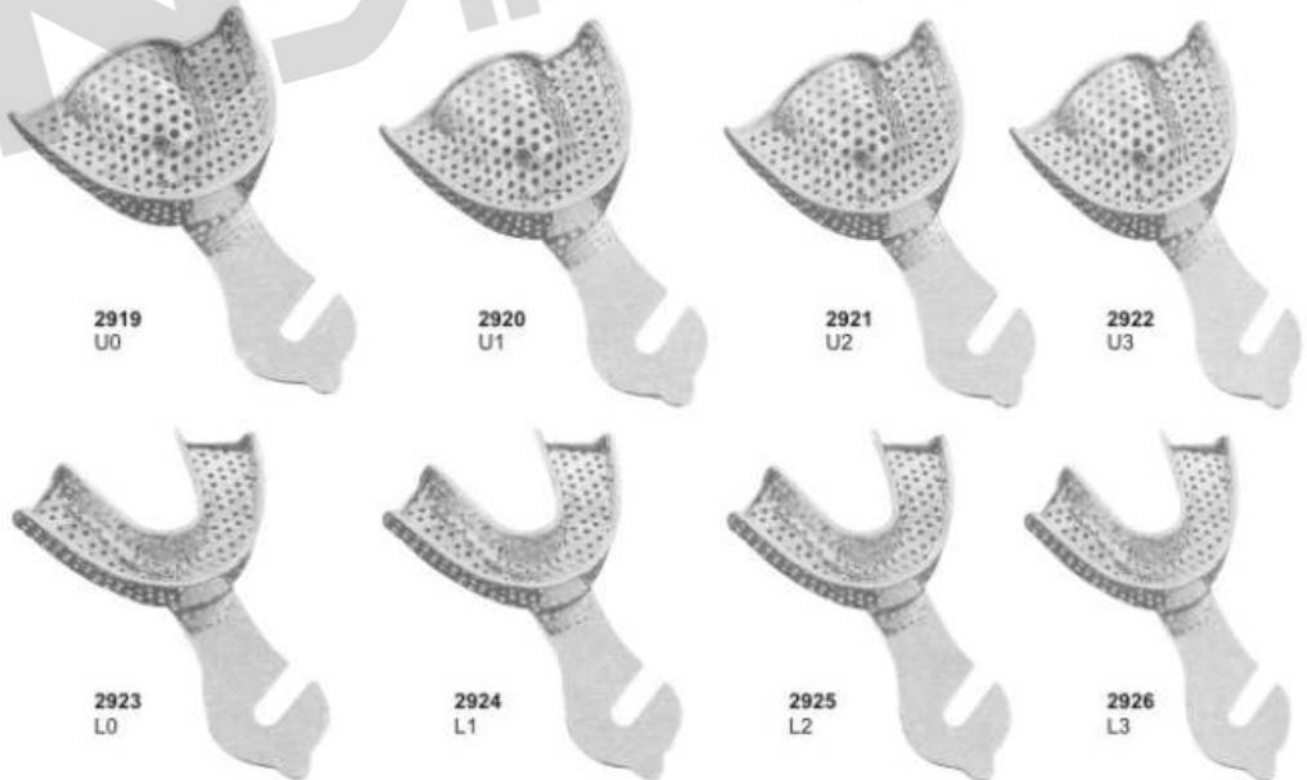

Made of 18/8 Stainless Steel, Perforated Full Denture Set of 8

## Impression Trays

### Impression Trays For Crown & Bridge Work

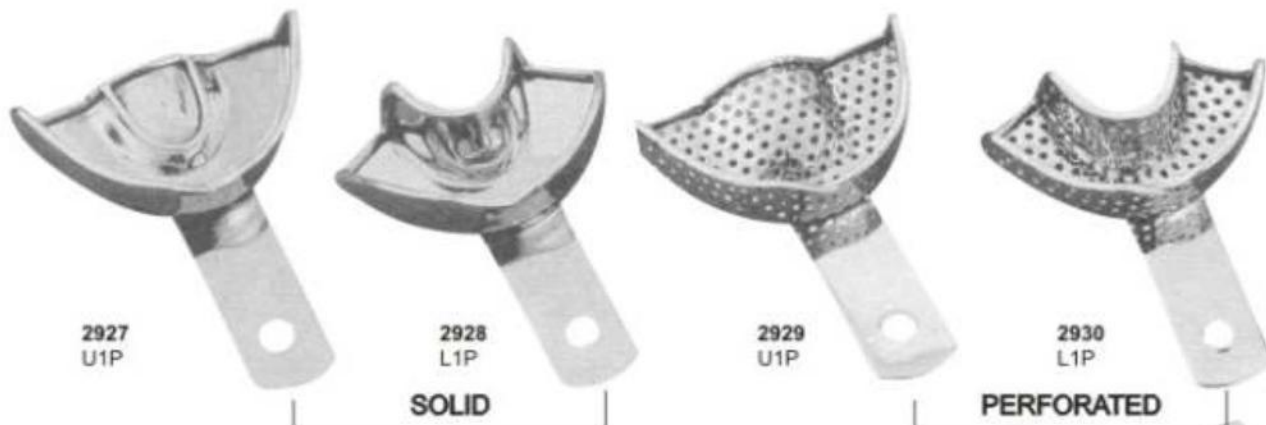

2927  
U1P

2928  
L1P

2929  
U1P

2930  
L1P

SOLID

PERFORATED



2932  
Adjustable  
Perforated



2933  
Adjustable  
Solid

PERFORATED

SOLID



2931-A  
For upper right jaw  
For lower left jaw

2931-B  
For upper left jaw  
For lower right jaw



2931-C  
For upper right jaw  
For lower left jaw

2931-D  
For upper left jaw  
For lower right jaw

Available in 4 sizes

- 1.....44 mm
- 2.....55 mm
- 3.....60 mm
- 4.....65 mm

Available in 4 sizes

- 1.....44 mm
- 2.....55 mm
- 3.....60 mm
- 4.....65 mm

## Articulators



2934



2935



2936



2937



2939



2938



## Articulators



2940



2941



2942



2943



2944



2945



2946



2947



## Hollow Wares



**2948**  
Instruments Tray of 20 Pcs

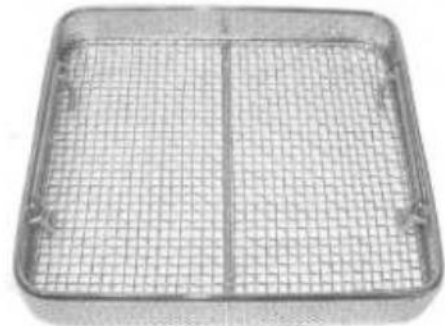

**2951**  
Instruments Riddle



**2949**  
Instruments Tray of 7 Pcs



**2949-A**  
Instruments Tray of 10 Pcs



**2950**  
Instruments Tray of 5 Pcs



**2952**  
Instruments Tray of 5 Pcs

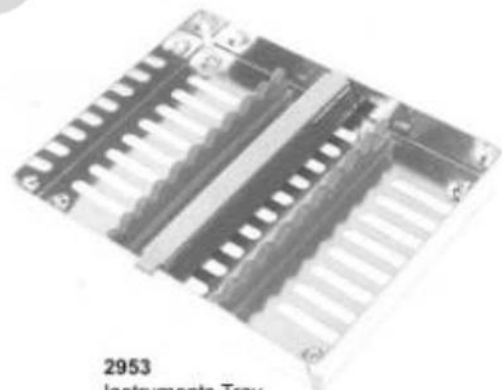

**2953**  
Instruments Tray



**2954**  
Instruments Tray  
Perforated



**2955**  
Instruments Tray  
Perforated Base



**2956**  
Instruments Tray  
Solid Base

## Hollowares



**2957**  
Pulpectomy Tray



**2958**  
Sterilizing Box  
Available Sizes:  
17x17x3 cm  
20x10x6 cm  
30x14x6 cm



**2959**  
Endo Tray Box



**2960**  
Finger Cup



**2961**  
Bur Box

**2962**  
Sterilizing Drum  
150x150mm  
175x175mm  
190x190mm  
200x140mm  
200x200mm  
240x120mm  
225x225mm  
240x240mm  
290x160mm



**2963**  
Sterilizing Drum  
280x240mm  
230x150mm  
300x250mm  
340x160mm  
350x250mm  
390x200mm  
380x300mm  
100x100mm  
150x120mm



## Sterilizing Boxes & Instruments Trays



2964  
Instruments Box



2965  
Instruments Box



2966  
Instruments Box



2967  
Instruments Sterilizer  
150x75 mm



2968  
Endodontic Box



2969  
Sterilizing Box  
320x120 mm



2970  
Instruments Tray



2971  
Instruments Tray



2972  
Instruments Tray  
(Perforated)



2973  
Instruments Tray  
Shallow(Mayo)



2974  
Scaler Tray  
20.0 x 10.0 x 1.5 cm



2975  
Scalers Tray



2976  
Scalers Tray



## Hollow Wares



2977

2978

2979

2980

Forcep and Thermometer Jars



2981

Cotton Holding Jar  
60x50 mm



2982

Spitten Mug

2983

Spirit Burner With Wick  
Stainless Steel 18/10  
Capacity: 150 ml, 60 ml

2984

Spirit Burners With Wick  
Stainless Steel 18/10  
Capacity: 70ml



2985

Dressing Jar

2986

Dressing Jar

2987

Irrigator(Douch Can)

2988

Measuring Jug



## Hollow Wares



**2989**  
Sponge Bowl



**2990**  
Wash Basin  
300mm-350mm-400mm



**2994**  
Kick Bucket With Trolley



**2991**  
Sponge Bowl



**2992**  
Gallipot



**2993**  
Medicine Cup



**2995**  
Kidney Tray Shallow  
150mm-200mm-240mm-300mm



**2996**  
Kidney Tray Without Lid  
150mm-200mm-250mm-300mm



**2997**  
Kidney Tray With Lid  
150mm-200mm-250mm-300mm

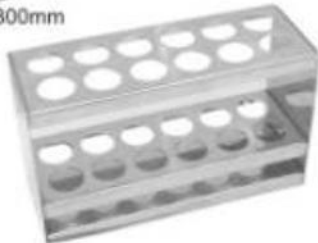

**2998**  
Tube Rack, Stainless Steel 18/10



**2999**  
Needle Case Rectangle  
Needle Case Round With Cover  
90x15



**3000**  
Dustbin Without Stand  
6-10-12 Ltr



**3001**  
Tube Rack, Round Model  
Stainless Steel 18/10



**3002**  
Dustbin Without Stand & Cap  
6-10-12 Ltr



**3003**  
Lotion Bowl With Lip  
40-60-80-100-120-150-180-200mm

## Scissors With Tungsten Carbide Inserts



**3004**  
Standard

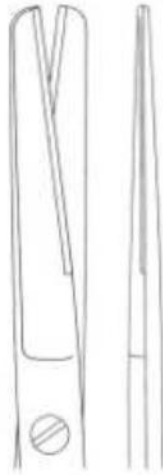

14,5cm  
16,5cm  
18,5cm



**3005**  
Standard

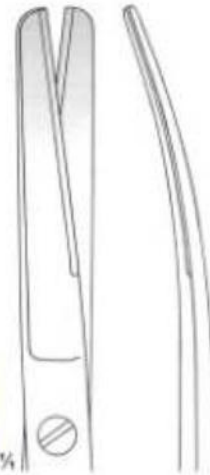

14,5cm  
16,5cm  
18,5cm



**3006**  
Standard



14,5cm  
16,5cm  
18,5cm



**3007**  
Standard

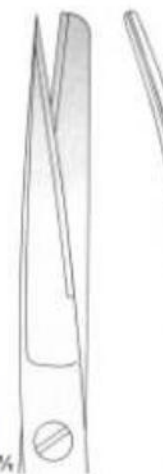

14,5cm  
16,5cm  
18,5cm



**3008**  
Standard



14,5cm  
16,5cm  
18,5cm



**3009**  
Standard



14,5cm  
16,5cm  
18,5cm

## Scissors With Tungsten Carbide Inserts

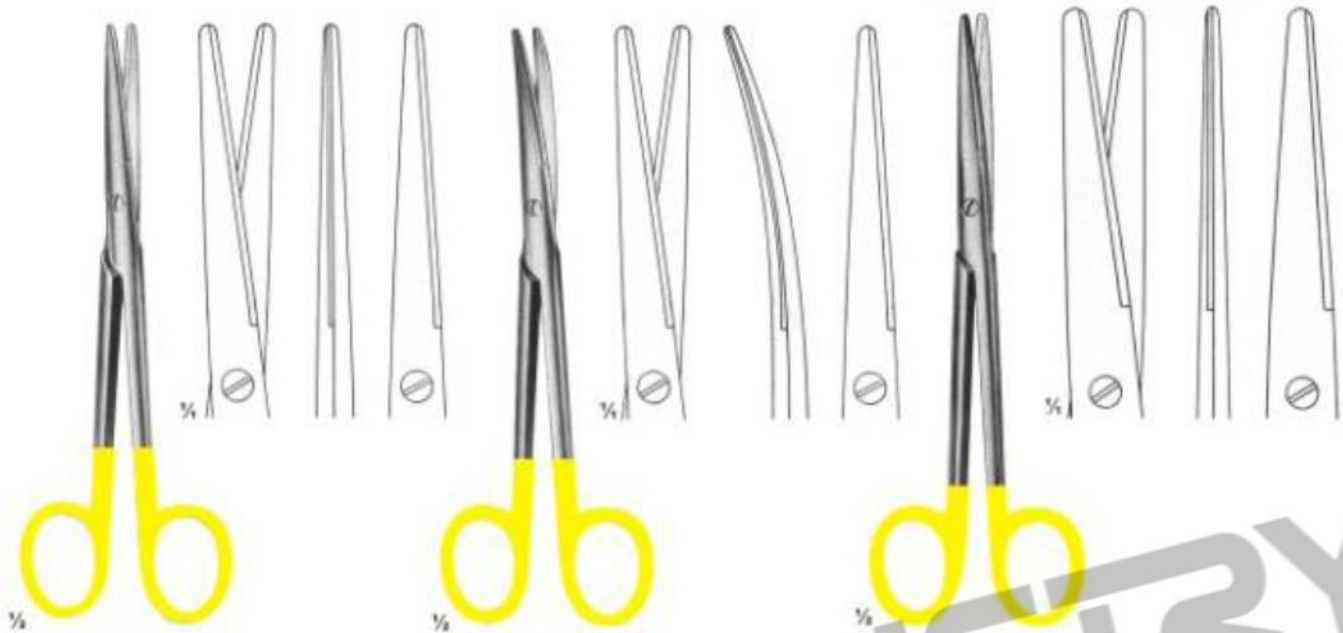

**3010**  
MAYO-LEXER  
Straight  
16 cm

**3011**  
MAYO-LEXER  
Curved  
16 cm

**3012**  
LEXER  
Straight  
16, 21 cm

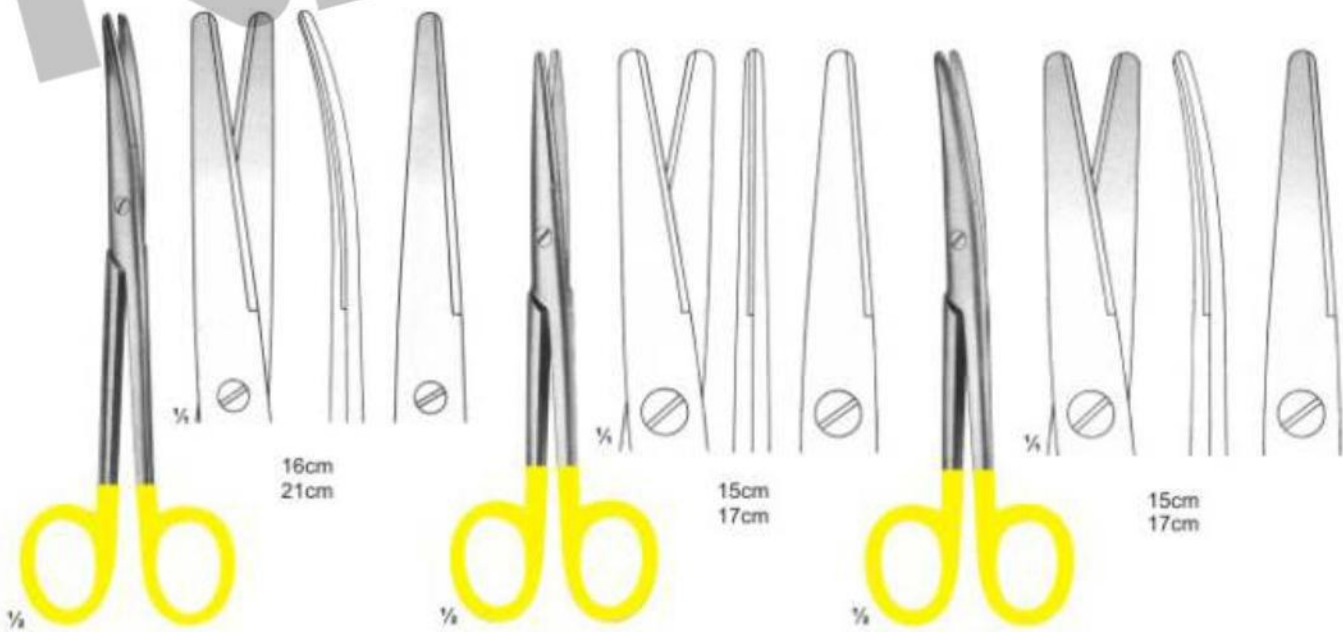

**3013**  
LEXER  
Curved  
16, 21 cm

**3014**  
MAYO-STILLE  
Straight  
15, 17 cm

**3015**  
MAYO-STILLE  
Curved  
15, 17 cm



## Scissors With Tungsten Carbide Inserts



**3016**  
METZENBAUM  
Straight



**3017**  
METZENBAUM  
Curved

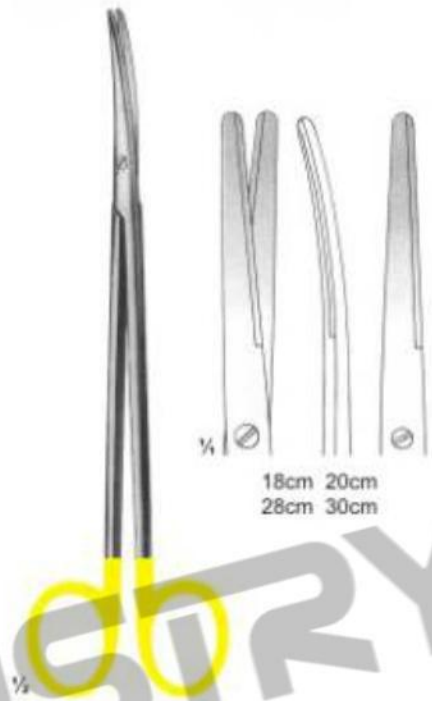

**3018**  
METZENBAUM  
Curved



**3019**  
METZENBAUM FINO  
Straight



**3020**  
METZENBAUM FINO  
Curved



**3021**  
METZENBAUM FINO  
Sharp

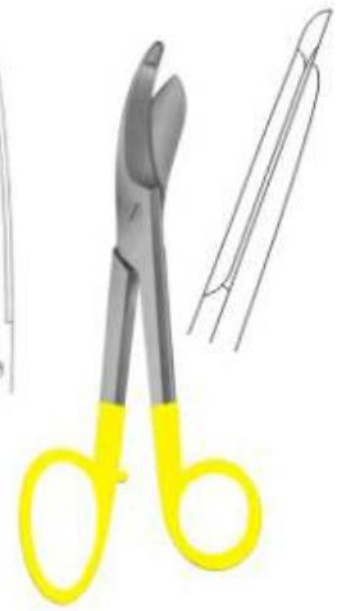

**3022**  
BRUNS  
235 mm



## Scissors With Tungsten Carbide Inserts



14cm 18cm  
20cm 23cm

3023  
METZENBAUM FINO

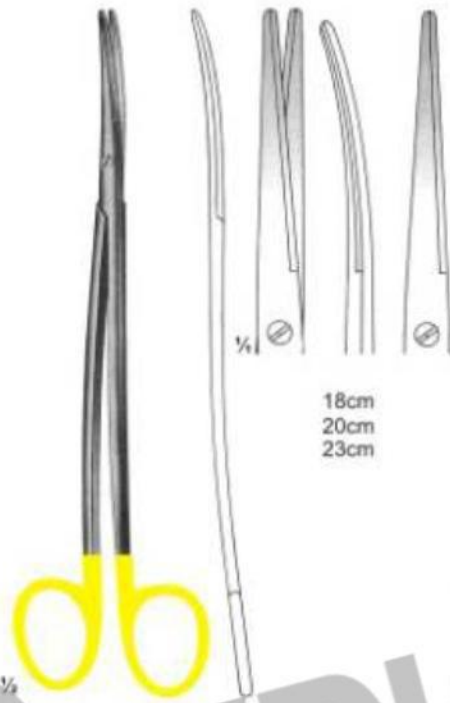

18cm  
20cm  
23cm

3024  
METZENBAUM FINO



18cm  
20cm  
23cm

3025  
METZENBAUM FINO



20cm  
23cm

3026  
METZENBAUM FINO

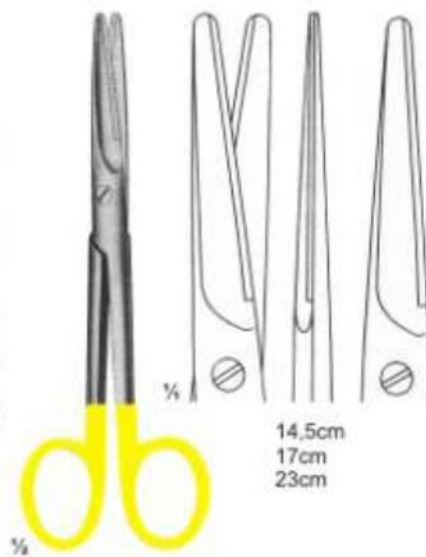

14,5cm  
17cm  
23cm

3027  
MAYO  
Straight

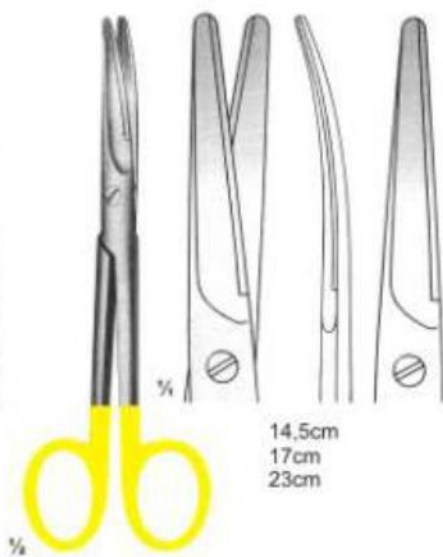

14,5cm  
17cm  
23cm

3028  
MAYO  
Curved

## Scissors With Tungsten Carbide Inserts



## Scissors With Tungsten Carbide Inserts



3036  
DE-BAKEY



3037  
DE-BAKEY

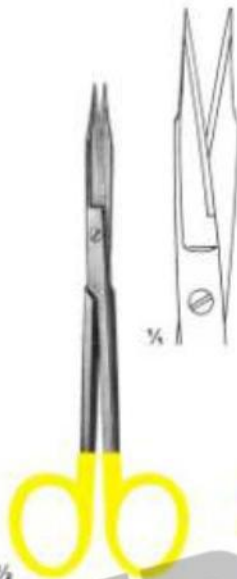

3038  
GOLDMAN FOX  
13 cm



3039  
GOLDMAN FOX  
Double-Curved  
13 cm



3040  
GOLDMAN FOX  
13 cm



3041  
Fine Scissors  
Straight  
11, 5 cm



3042  
Fine Scissors  
Curved  
11, 5 cm



3043  
Fine Scissors  
Angled  
11, 5 cm



3044  
RAGNELL  
Curved  
12 cm



## Scissors & Dissecting Forceps With Tungsten Carbide Ins

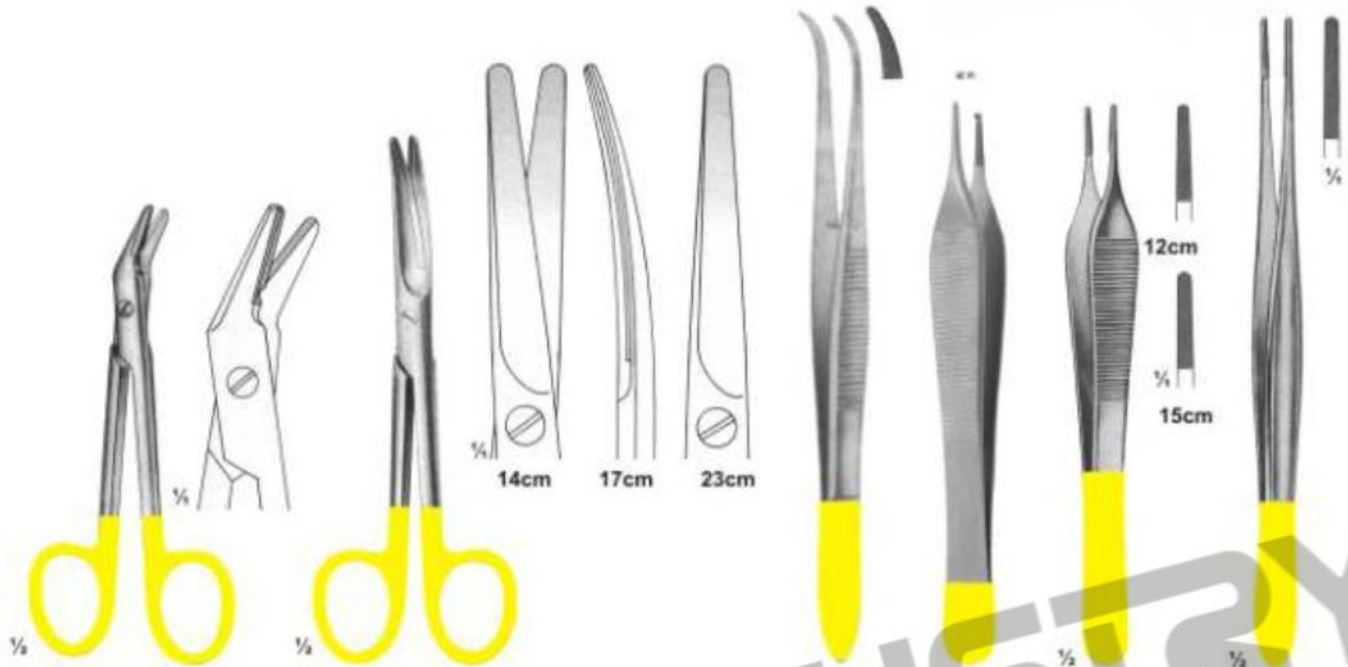

**3045**  
UNIVERSAL  
12cm

**3046**  
Ligature Scissors  
1 Black & 1 Goldplated ring

**3047**  
MERIAM  
16 cm

**3048**  
ADSON

**3049**  
ADSON

**3050**  
CUSHING  
17,5 cm



**3052**

**3053**

**3054**

**3055**

150 mm

200 mm

240 mm

300 mm

**3051**  
DE BAKEY  
17,5 cm

**3056**  
CASTROVIEJO  
Curved  
15 cm

**3057**  
CUSHING  
18 cm

**3058**  
CUSHING-TAYLOR  
18 cm

**3059**  
Dressing  
Forceps  
15 cm

**3060**  
SEMKEN  
15 cm

**3061**



## Dissecting Forceps & Needle Holders T.C Instrume

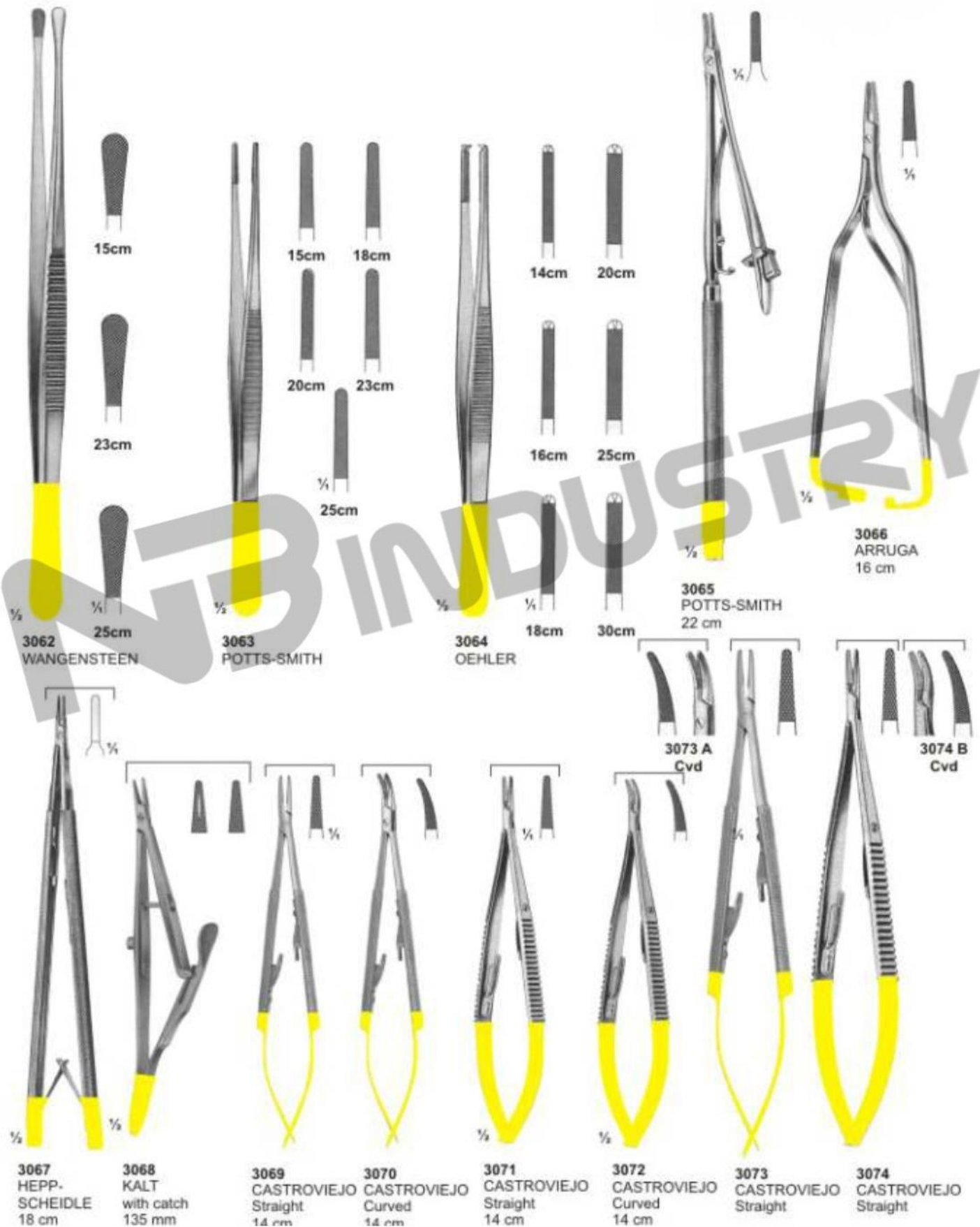

## Needle Holders With T.C. Inserts

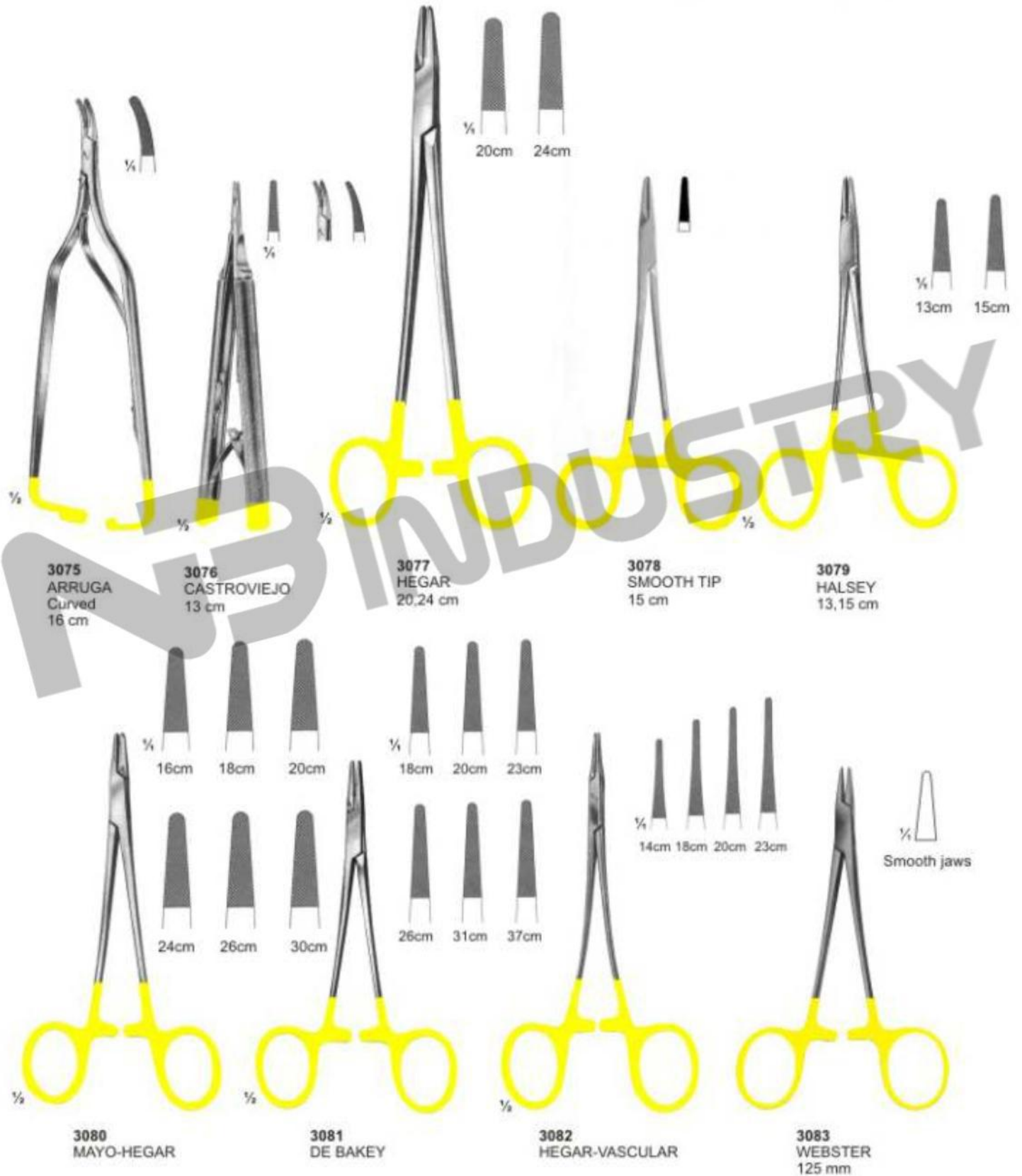

## Needle Holders With Tungsten Carbide Inserts

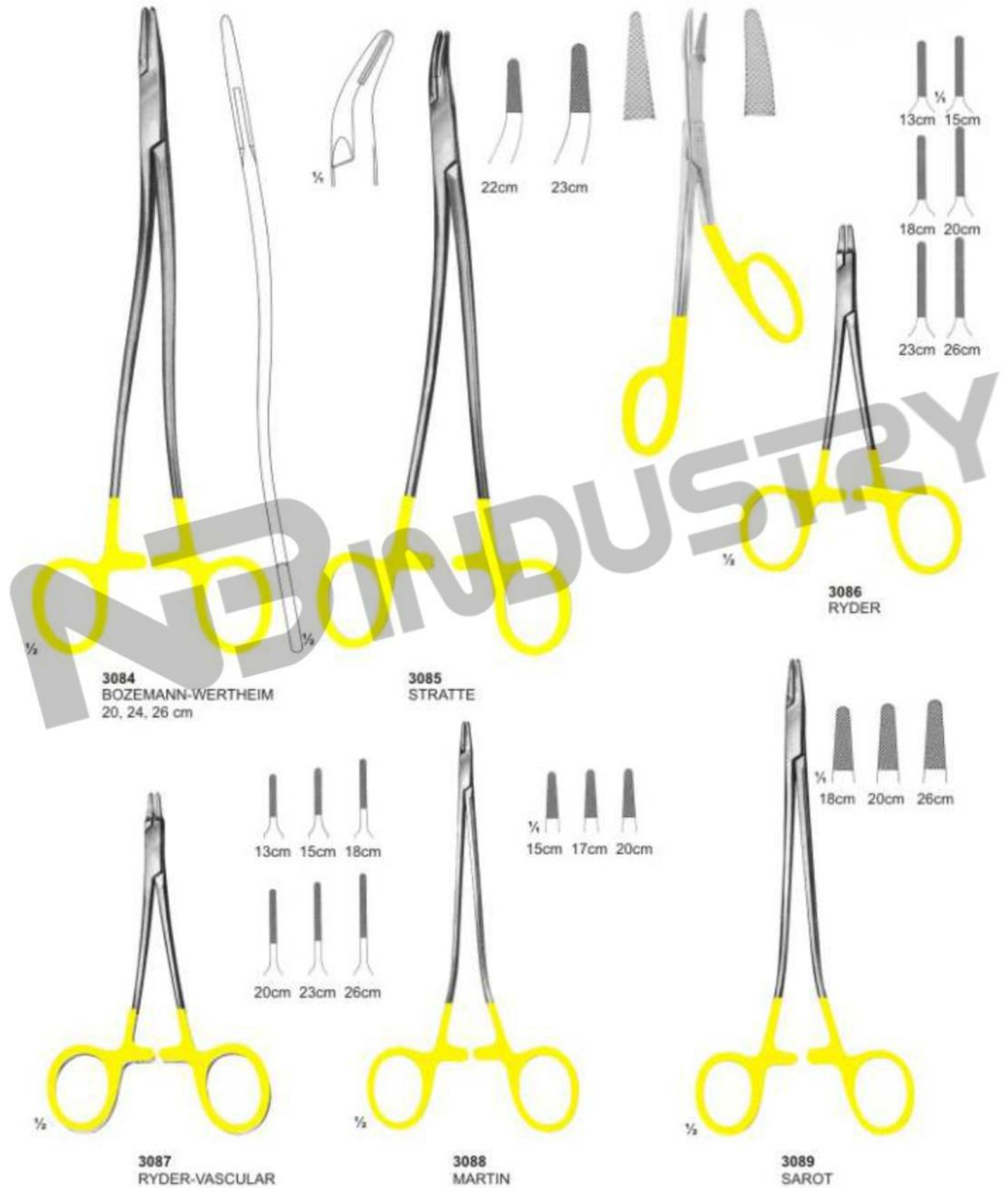



## Needle Holders With Tungsten Carbide Inserts





## Needle Holders With T.C. Inserts



## Wire Cutting Plier With T.C. Inserts



**3109**  
TOENNIS  
Elastic pattern for  
dura-or intestinal suture  
180 mm



**3110**  
Cutting Plier  
12 cm



**3111**  
MULLAR CLAUS  
22 cm



**3112**  
Plier  
17.5 cm

## Alphabetical Index

### A

Adams, Pliers	174
Aderer, Pliers	174
Adson, Forceps	158,207
Adson, Tweezers	151
Ainsworth, Rubber Dam Punch	147
Albee	143
Albrecht, Tweezers	155
Allen, Tweezers	155
Allis, Tissue Forceps	158
Amalgam Applicators	97
Amalgam Condensers	97
Amalgam Pluggers	97
Amalgam Carriers	145
Amalgam Guns	145
Andresen, Pliers	175
Andrews, Tongue Depressor	160
Angle, Pliers	169,174
Apical, Elevator	57,63
Arruga, T.C. Needle Holder	208,209
Articulators	194-195
Aspirating Syringes	149
Allen 9A, Elevator	50

### B

Baby-Allis, Tissue Forceps	158
Band Removing Pliers	170
Bane, Rongeurs	179
Barnhart, Curettes	110,116
Barry, Elevator	66,69
Baum Gartner, Needle Holder	180,211
Bee Be, Scissors	186
Bein, Elevator	54,61
Beyer, Rongeurs	179
Bird Beak Pliers	167
Blumenthan, Rongeurs	176
Boley Gauge	143
Bone Curettes	129
Boynton, Needle Holder	181
Bozemann-Wertheim, T.C. Needle Holder	210
Bracket, Pliers	170
Brewer, Rubber Dam Instruments	147
Brown, Tissue Forceps	158
Brown-Adson, Tissue Forceps	158
Bruns, T.C. Scissors	203
Buchs, Retractor	162
Burnishers	99-100
Ball Chain	146
Boley Gauge,	143

Bone Gauge,	144
Bone Mill Forcep,	139
Bone Pluggers,	140
Bracket, Gauge	144
Buser, Elevator	52

### C

Carvers	102,103
Castroviejo, Needle Holder	181,208,209
Castroviejo, scissors	186
Castroviejo, Gauge	144
Castroviejo, Sclerer Marker	144
Cement Instruments	118,119,121
Cement Spatulas	120,122
Chisels	103
Chompret, Elevator	63
Cleveland, Rongeurs	177,178
College, Tweezers	152,154
Collier, Needle Holder	180
Collin, Retractor	162
Columbia, Curettes	110,111,116
Composite Placement	104,105
Con Scodellino, Wax Knives	126
Cord Packers	95
Cottle, Scissors	184
Coupland, Elevator	58
Crane-Kaplan	128
Crile, Forceps	157
Crile, Needle Holder	181
Crile-Wood, Needle Holder	180
Crown Instruments	135,136
Crown Removers	134,135
Crown Shell, Pliers	166
Cryer, Elevator	55,58,69
Cushing, T.C. Forceps	207
Cushing, Tweezers	151
Cushing-Taylor, T.C. Forceps	207

### D

De Bakey, T.C. Forceps	207
De Bakey, Scissors	184,186,206
De Bakey, T.C. Needle Holder	209
De La Rosa, Pliers	169
Deaver, Scissors	184
Denhart, Mouth Gag	160
Derf, Needle Holder	180
Disposable Products	117
Dr.Sader, Elevator	69
Dressing Forceps	207
Dean Scissors	186,205



## Alphabetical Index

### E

Elevators	51
Endodontic Condensers	86,87
Ernert, Wax Knives	126
Excavators	89-91
Explorers	80-82,91-94
Extracting forceps (American Pattern)	36-49
Extracting forceps (English Pattern)	1-24
Extracting forceps (fitting handle)	25-33
Extracting forceps (For Children)	34

### F

Fahnenstock, Wax Knives	126
Files	125
Filling Instruments	106,107
Fine, T.C. Scissors	206
Finocchio, T.C. Needle Holder	211
Finocchio, T.C. Needle Holder	211
Fischer, Pliers	175
Flagg, Tweezers	154
Flohr, Elevator	56
Fomon, Tissue Retractor	164
Freer, Elevator	52
Friedman, Rongeurs	178
Furrer, Pliers	174
Film Hanger	146
Finger Cup	197
Flohr, Elevator	57
Freer	15,16,
Elevator	52

### G

Gardner, Bone Chisels	132
Gardner, Needle Holder	180
Gardner, Rongeurs	178
Gillies, Hook	164
Gillies, Tweezers	151
Goldman Fox, T.C. Scissors	206
Goldman Fox, Curettes	112,113
Goldman Fox 14, Elevator	50
Goldman Fox, knives	114
Goslee, Pliers	175
Gracey Curettes	108,109,116

### H

Halsey, T.C. Needle Holder	209
Handles	72
Hartman, Rongeurs	179

Hatchets	95
Heaney, T.C. Needle Holder	211
Hegar, T.C. Needle Holder	209
Hegar-Vascular, T.C. Needle Holder	209
Heidbrink, Elevator	64,67,69
Heidbrink, Elevator	57
Howard 9H, Elevator	52
Height Gauge,	143
Hepp-Scheidle, T.C. Needle Holder	208
Hlsted-Mosquito, Forceps	159
Hoes	95,125
Hollow Wares	196-200
How, Pliers	167,174
Howard, Bone Files	131
Hylin, Elevator	61

### I

Implants Instruments	
Impression Trays	137-141
Iris Scissors	187-193
Ivory, Rubber Dam Instruments	183
	147

### J

Jarabak, Pliers	165
Joseph, Scissors	183
Johnson, Pliers	169,175
Joseph, Tissue Retractor	164

### K

Kalt, T.C. Needle Holder	208
Kelly, Forceps	159
Kelly, Scissors	183
Kelly Scissors	205
Kim's Plier	165
Kirkland, knife	114
Knives	125
Knowles, Scissors	184
Kocher, Retractor	162
Kocher-Langenbeck, Retractor	162
Kopp, Elevator	60,68
Kopp, Tweezers	151

### L

Lab & Office Pliers	166
Landgraf, Tweezers	154
Langenbeck, Pliers	175
Langenbeck, Retractor	162



## Alphabetical Index

Langenbeck, T.C. Needle Holder	212
Langer, Curettes	110,116
Langhals, T.C. Needle Holder	212
Lecluse, Elevator	65
Lessmann, Wax Knives	126
Lexer, T.C. Scissors	202
Lichtenberg, T.C. Needle Holder	212
Ligature, T.C. Scissors	207
Lip & Cheek Retractors	161,162
Lister, Scissors	184
Littauer, Scissors	186
Littler, Scissors	184
Locklin, Scissors	186
London Hospital, Elevator	62
London-College, Tweezers	154,155
Lucae, T.C. Forceps	
Luehty-Beck, T.C. Needle Holder	212
Lwanson, Crown Gauge	143
Lagrange, Scissors	186,205
Littaure, Scissors	186
Lwanson, Crown Gauge	143

### M

Martin, T.C. Needle Holder	210
Mathieu, Needle Holder	181,211
Mathieu-Kosher, T.C. Needle Holder	211
Mathieu-Ryder, T.C. Needle Holder	212
Mathieu-Vascular, T.C. Needle Holder	211
Mayo Harrington, T.C. Scissors	205
Mayo, Scissors	185,204
Mayo-Hegar, Needle Holder	181
Mayo-Hegar, T.C. Needle Holder	209
Mayo-Lexer, T.C. Scissors	202
Mayo-Stille, T.C. Scissors	202
Mayo-Stille Scissors	185
Mc Kellops, Pliers	175
Mccalls, Curettes	110,111,116
Mcindoe, Tweezers	151
Mead, Bone Mallets	133
Mead, Elevator	64
Mead, Rongeurs	179
Meriam, T.C. Forceps	207
Meriam, Tweezers	153,155
Metzenbaum Fino, T.C. Scissors	203,204
Metzenbaum, Scissors	185,203
Micro Surgery Set	182
Micro-Adson, Tweezers	151
Micro-Friedman, Rongeurs	178
Middledorpf Retractor	162
Miller, Articulating Forceps	147
Miller, Bone Files	130

Mini-Blumenthan, Rongeurs	176
Molt, Elevator	50
Molt, Mouth Gag	160
Molt 9, Elevator	50
Morrison, Elevator	56
Mouth Mirrors with Handles	73
MSY, Pliers	175
Mullar Claus, Wire Cutting Pliers T.C.	213

### N

Nance, Pliers	168,169,174
Napkin Holders	146
Neivert, Needle Holder	180
Nelson-Metzenbaum, Scissors	185
Non Chill	146

### O

O'Brien, Pliers	168
Obturation Instruments	88
Ochsenbein	128
Ordan, knife	114
Oehler, T.C. Forceps	208
Olsen-Hegar, Needle Holder	180
Optical Pliers	168
Orthodontic Cutters, T.C.	172
Orthodontic Distal & Cutters	173
Orthodontic Pliers, T.C.	171
Ott, Elevator	62

### P

Parametrium, T.C. Scissors	205
Partsch, Bone Chisels	133
Partsch, Bone Mallet	133
Pean, Forceps	157
Peeso, Pliers	166,175
Peets, Forceps	157
Perry, Tweezers	151
P.K. Thomas,	96
Pich,	98
Pluggers,	98
Prichard, Elevator	50
Plastic Handle Elevators	70
Polokoff, Bone File	131
Pott, Elevator	51
Potts-Smith, T.C. Forceps	208
Potts-Smith, T.C. Needle Holder	208
Probes	82-85,91,94

### Q

Quinby, Scissors	183
------------------	-----

## Alphabetical Index

### R

Ragnell , T.C. Scissors	206
Retainers, Bands	146
Reynolds, Pliers	169,174
Root Planning Curettes	115
Root splinter forceps	35
Roux, Retractor	162
Rubber Dam Clamps	148
Rubber Dam Holder	147
Rule, Curette	110
Russian, Tissue Forceps	158
Ryder, T.C. Needle Holder	210
Ryder-Vascular, T.C. Needle Holder	210

### S

Sarot, T.C. Needle Holder	210
Scalers	75-79
Scalpel Handles	71
Schwarz, Pliers	168,175
Schluger, File	114
Seldin, Elevator	50,55,67
Select, Tweezers	151
Semken, T.C. Forceps	207
Semkin, Tissue Forceps	158
Senn, Tissue Retractor	164
Separating Pliers	166
Sims, T.C. Scissors	205
Spatulas	123
Spencer, Scissors	186
Spencer-Wells, Forceps	157
Spreaders	87
Split Chisels,	128
Spring Bow Divider	143
Standard, T.C. Scissors	201
Standard, Tweezers	151
Steiner, Pliers	166
Sterilizing & Lab Instruments	156
Sterilizing Forceps,	163
Stevens, Needle Holder	181
Stevens, Scissors	183
Stille, Scissors	185
Stratte, T.C. Needle Holder	210
Strip Holder Clips	146
Syringes	150
Suction Tubes,	140,142
Sugarman, File	114

### T

Toennis, Wire Cutting Pliers T.C.	213
-----------------------------------	-----

Toennis-Adson, Scissors	184
Toennis, Tissue Retractor	164
Towel Clamps, Napkin Holders	159
Tweed, Pliers	168
Telescope, Crown Plier	136
Traymann, Crown Remover	128

### U

Universal , T.C. Scissors	207
Universal, Pliers	174
Universal, Elevator	135
Utility Plier	165

### V

Vernier, Measuring Instruments	143
Vernier Gauge	143

### W

Wakefield, Bone Chisels	132
Waldron, Pliers	174
Waldsachs, Pliers	174
Wangensteen, T.C. Forceps	208
Warwick-James, Elevator	62
Waugh, Tweezers	151
Wax & Modeling Carvers	120
Wax & Plaster Knives	127
Wax Carvers	101
Wax, Porcelain Instruments	118,119,121
Webster, Needle Holder	180,209
Weingart , Utility Pliers	167
Weitlaner, Retractor	160
West, Elevator	50
White, Rubber Dam Instrument	147
Wieder, Tongue Depressor	160
Winter, Elevator	65,69
Wire & Clasp Bending Pliers	170
Wire Bending Pliers	166
West, Elevator	50
Wire Cutter	165
Woodson,	98

### Y

Young, Pliers	168,174
---------------	---------

### Z

Zuricher, Measuring Instrument	143
Zuricher, Gauge	143





# **N3** INDUSTRY

Quality Is Our Priority

**ADDRESS:**

N3industry Old Adalat Garh,  
Sialkot, Punjab, Pakistan.

**Cell:** +92-300-7418875  
+92-322-7378008

**Email:** [info@n3industry.com](mailto:info@n3industry.com)

**Web:** [www.n3industry.com](http://www.n3industry.com)